

- Input for potentiometers
- Analog output
- Up to 7 200 measurements/s
- Quick configuration by DIP switch
- PC configurable via USB port
- Galvanic isolation 2.5 kVAC
- Simple installation to DIN rail

MUP-410

Digital DIN rail mounted signal converter

INPUT FOR POTENTIOMETERS

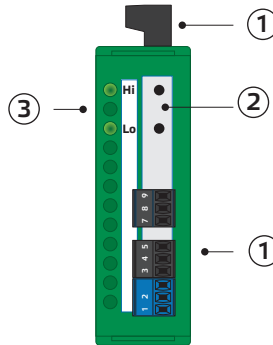
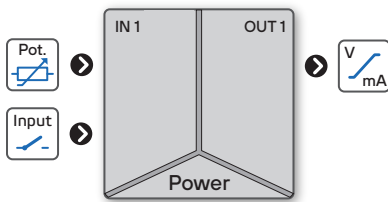

LED Indication

Hi	Lo	Status
●		Device is running
✱		Device functionality is limited, powered via USB
✱		This device has a Delayed Start option
●		Error: device is out of order
●	○	Tare function is activated
●	●	Error: of input (> ±110% of range) or of sensor [ERR.1, 3]
●	●	Error: AO loop open [ERR.10]
●	●	Error: setting/ calibration [ERR.34-36]
✱	✱	Serious error (Safe mode) [ERR.50]
✱	✱	Button function is blocked
●	●	Simulation mode is activated

Legend

- 1 Connectors
- 2 Control button
- 3 RGB Status LED

HAZARD

HAZARD OF ELECTRICAL SHOCK

- Disconnect all power and other supply lines before servicing equipment

Failure to follow this instruction may result in death or serious injury.

WARNING

EQUIPMENT OPERATION HAZARD

- Do not use this product in safety critical system
- Do not disassemble, repair or modify this product
- Do not operate beyond the recommended operating environment

Failure to follow these instructions may result in death, serious injury, or equipment damage.

Electrical equipment should be installed, operated, serviced, and maintained only by qualified personnel.

No responsibility is assumed by Novotechnik Messwertaufnehmer OHG for any consequences arising out of the use of this device.

2

Connection

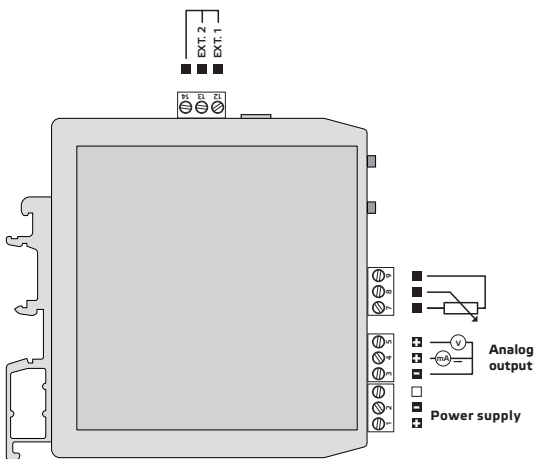

Note

Contactors, high power electric motors, frequency drives and other power devices should not be in a close proximity of the meter. Input signal leads (measured value) should be separated from all power lines and power devices. Even though the device has been designed and tested according to standards for industrial environment, we strongly advise to adhere to the above presented rules.

	0,05...2,5mm ² 30...12 AWG	
	Ø 3,5 mm Ø 0.14 in	 1,5 Nm 13.2 lb-in

Input wiring diagram

Input - Potentiometers

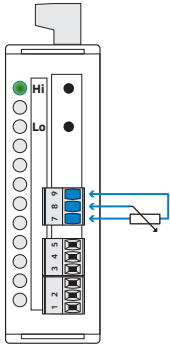

Input - External inputs

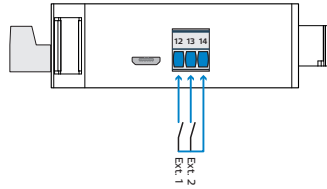

Control of external inputs is via contact (voltage-free)

Output wiring diagram

Analog current output [mA]

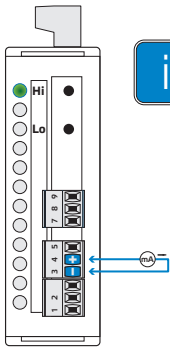

Caution:
The signal conditioner is not to be used as part of a 2-wire current loop configuration.

Analog Voltage Output [V]

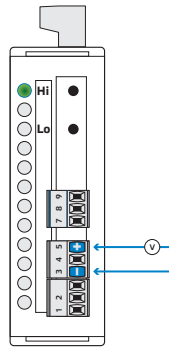

Analog output	
0...5/20 mA	3 - 4
4...20 mA	
0...2/5/10 V	3 - 5
±10 V	

3 Device setting

Functions of DIP switches

To set up a configuration, e.g. the measuring rate or the output interface, you can use the DIP switches (see chapter 3.2). Changing a configuration only takes effect after power off/on.

1 Input	2 Key Lock	3 4 5 Rate [measurements/s]	6 7 8 Output - range
Working Mode includ. Teach-IN, Tare (default)	Device buttons active (default)	50	0...2 V
Data transfer of a change of DIP switches No. 3 - 8 as well as Reset Teach-IN, Tare	Device buttons blocked	100	0...5 V
		400	0...10 V
		400 - FFT	±10 V
		1200	0...5 mA
		2400	0...20 mA
		4800	4...20 mA (default)
		7200 (default)	20...4 mA

ON
OFF
Positions
DIP switches
ON/OFF

3.1 Default Settings

The signal conditioner is factory-set in working mode with a measuring rate of 7200 measurements/s and an output range of 4...20 mA.

Teach-in and tare are possible as described in chapters 3.3 and 3.4.

Changing of this configuration, e.g. to another analog output, is described in chapter 3.2.

3.2 Change the configuration via DIP switches No. 3 - 8 and Reset to factory settings

Changing of configuration (e.g. change to another output range) must be carried out before Teach-In or Tare. Resetting to factory settings resets the teached measuring range or Tare, too.

- DIP switch No.1 ON
- Setting the new configuration using DIP switches no. 3 to 8
e.g. change of output to 0...10 V => change of DIP switches to 6 OFF, 7 ON, 8 OFF
- Reset (= Power off/on) => Changes to the configuration take effect
- DIP switch No.1 OFF => Working Mode



Setting of **Analog input TEACH-IN** is active only when DIP switches No. 1-2 are in the OFF position.

3.3 Analog input range setting (Teach-IN)

- Enter the teach-IN mode by a short press of the **Lo** button - LED **Hi** yellow and LED **Lo** turquoise
 - Put the connected sensor in the position that shall have minimum output (**RNG.MIN**)
 - Set the minimum output value by a long press (> 2 s) of the **Lo** button - LED **Hi** yellow, LED **Lo** purple
 - Put the connected sensor in the position that shall have maximum output (**RNG.MAX**.)
 - Set the maximum output value by a long press (> 2 s) of the **Lo** button - LED **Hi** yellow, LED **Lo** green
 - Leave teach-IN mode by a short press of the **Lo** button and return to the standard working mode - LED **Hi** green
- The teached measuring range is non volatile and retained even after power off/on. Reset of measuring range see chapter 3.1.
Beyond the teached measuring range, the output values can exceed the minimum/maximum values (e.g. < 4 mA, > 20 mA).



In order to avoid possible unintended changes to settings by accidentally pressing the **Hi** and **Lo** buttons, these buttons can be **disabled** by connecting **terminals No. 12 and 14** of external input Ext. 1 (wire jumper).

Zero settings (Tare)

Tare via Buttons

- Enter the tare mode by a short press of the **Hi** button - LED **Hi** white and LED **Lo** turquoise
- Put the connected sensor in the position where the tare function shall be executed
- Set the tare by a long press (> 2 s) of the **Hi** button - LED **Hi** white, LED **Lo** green
- Leave tare mode by a short press of the **Hi** button and return to the standard working mode - LED **Hi** green, LED **Lo** white



The teach-IN or tare mode is terminated immediately and without storage by a short press of **Lo** or **Hi** buttons or 1 minute of inactivity.

Tare via External Input Ext. 2

- Put the connected sensor in the position where the tare function shall be executed
- Set the tare by a brief interconnection of external input Ext. 2 (< 1 s) - LED **Lo** white

Tare sets output at the current position to the value of the minimum output signal (e.g. 0 V, 0 mA, 4 mA, 20 mA). Tare is non volatile and retained even after power off/on. Reset of tare can be done either by external input Ext 2 (> 2 s) or via factory reset acc. to chapter 3.1.

4 Instrument dimensions and installation

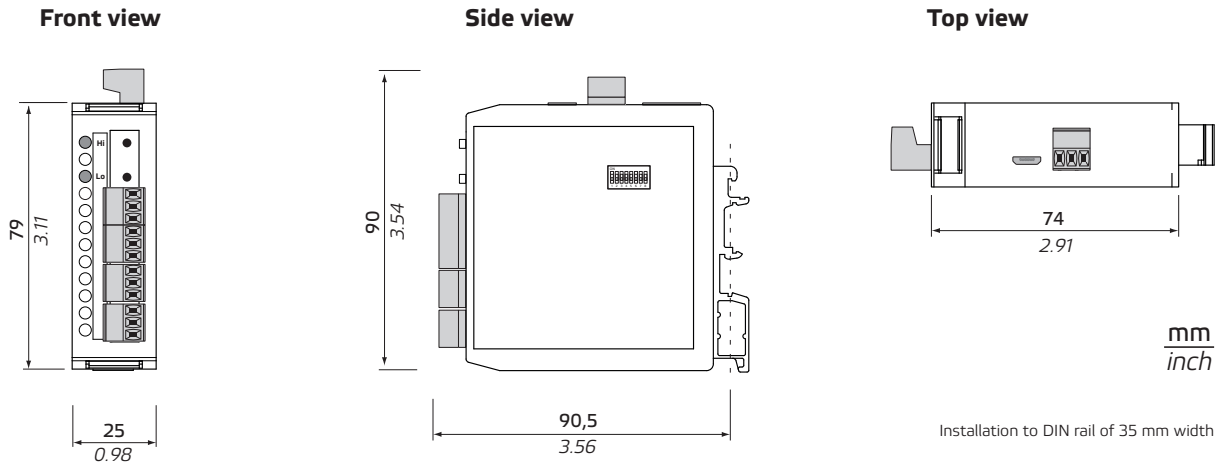

5 Technical data

INPUT

No. of inputs	1
Setting	24-bit $\Delta\Sigma$ ADC with PGA The range is selectable either by DIP switch or by OM Link free SW from PC
Power	2.5 VDC/5 mA, potentiometer resistance > 500 Ω

EXTERNAL INPUT

No. of inputs	2
Function EXT 1	KEYLOCK Device buttons blocked (see ch. 3 Device setting)
Function EXT 2	Set of Tare (< 1 s) Reset of Tare (> 2 s)

INSTRUMENT SPECIFICATION

TC	15 ppm/ $^{\circ}$ C
Accuracy	$\pm 0.01\%$ of FS
Rate	100...7 200 measurements/s speed of 400 meas./s is with FFT signal filtering
Latency	< 580 μ s
Overload	10x (t < 30 ms), 2x
Functions	Teach-in, Tare, Math, functions, Simulation (only via OMNI Link)
Digital filters	exponential/floating/arithmetic average, rounding (only via OMNI Link)
Math functions	polynomial/inverse polynomial/logarithm/exponential/power/root (only via OMNI Link)
Linearization	linear interpolation in 100 points (only via OMNI Link)
OMNI Link	On request: company communication interface for operation, setting and update of instrument (microUSB).
Watch-dog	reset after 500 ms
Calibration	at 25 $^{\circ}$ C and 40 % r.h.

ANALOG OUTPUT

No. of outputs	1
Type	isolated, adjustable with 16-bit DAC, output type and range is selectable
TC	15 ppm/ $^{\circ}$ C
Non-linearity	0.024 % of FS
Accuracy	$\pm 0.02\%$ of FS $\pm 0.03\%$ of FS $\pm 0.05\%$ of FS
Rate	response to change of value < 160 μ s
Output signals	0...2/5/10 V, ± 10 V, resistive load ≥ 1 k Ω 0...5/20 mA/4...20 mA, comp. < 500 Ω /12 V
Output in case of sensor wire break	0...2 V approx. 2.2 V 0...5 V approx. 5.5 V 0...10 V approx. 11 V 0... ± 10 V approx. 11 V 0...5 mA approx. 5.5 mA 0...20 mA approx. 22 mA 4...20 / 20...4 mA approx. 3.2 mA

POWER SUPPLY

Power	10...30 VDC/24 VAC, $\pm 10\%$, 2.5 VA, PF ≥ 0.4 , $I_{STP} < 40$ A/1 ms, isolated Fuse inside (1500 mA)
-------	--

MECHANIC PROPERTIES

Material	PA66, incombustible UL 94 V-0, green
Dimensions	25 x 79 x 90.5 mm (w x h x d)
Installation	to DIN rail 35 mm wide

OPERATING CONDITIONS

Connection	connector terminal blocks, section < 1.5 mm ²
Stabilization period	within 5 minutes after switch-on
Working temp.	-20 $^{\circ}$...60 $^{\circ}$ C
Storage temp.	-20 $^{\circ}$...85 $^{\circ}$ C
Working humidity	< 95 % r.h., non condensing
Protection	IP20
Construction	safety class I
El. safety	EN 61010-1, A2
Dielectric strength	2.5 kVAC for 1 min. between power supply and signal input 2.5 kVAC for 1 min. between signal input and outputs
Insulation resistance*	for pollution degree II, measurement cat. III power supply > 300 V (PI), 255 V (DI) Input/outputs > 300 V (PI)
EMC	EN 61326-1 (Industrial area)
RoHS	EN IEC 63000 : 2018
Seismic qualification	IEC/IEEE 60980-344 Edition 1.0, 2020, par. 6, 9
Mechanical resistance	EN 60068-2-6 ed. 2:2008

* PI - Primary insulation, DI - Double insulation

6 Error Messages

Error	Error description	Solution
ERR 1	Input range exceeded by $\pm 10\%$ or more.	Change input signal value or input setting (range).
ERR 3	Potentiometer wire broken.	Check sensor cable and connection.
ERR 10	Output current loop broken.	Check cable and current loop connection.
ERR 34	User configuration could not be loaded from EEPROM. Default configuration automatically applied.	Repeat device configuration. If message is shown repeatedly, send the device for repair.
ERR 35	Factory calibration has been lost. Converter's accuracy is compromised up to $\pm 5\%$	When this error occurs, send the device for re-calibration or upload factory calibration data.
ERR 36	User calibration could not be loaded from EEPROM. Factory calibration automatically applied.	Repeat the user calibration. If message is shown repeatedly, send the device for repair.
ERR 50	Serious device error - damaged EEPROM. The device operates in an emergency mode, i.e. settings cannot be changed. Measurement error can be up to 5%	Send the device for repair.



novotechnik
Siedle Group

Novotechnik Messwertaufnehmer OHG
Horbstrasse 12, 73760 Ostfildern,
Germany

+49 711 4489-250 @ support@novotechnik.de