



MAP 4000

4 DIGIT PROGRAMMABLE UNIVERSAL INSTRUMENT

DC VOLTMETER / AMMETER
PROCESS MONITOR
OHMMETER
THERMOMETER FOR PT 100/500/1 000
THERMOMETER FOR NI 1 000
THERMOMETER FOR THERMOCOUPLES
DISPLAYS FOR LIN. POTENTIOMETERS



SAFETY INSTRUCTIONS

Please, read the enclosed safety instructions carefully and observe them!
These instruments should be safeguarded by isolated or common fuses (breakers)!
For safety information the EN 61 010-1 + A2 standard must be observed.
This instrument is not explosion-safe!

Our products are regularly not approved for aeronautic or aerospace applications and are not allowed to be used in nuclear or military, in particular ABC-relevant applications.

For more information see our Terms and Conditions

TECHNICAL DATA

Measuring instruments of the MAP 4000 series conform to the European regulation 89/336/EWG and the Ordinance 168/1997 Coll.

The instruments are up to the following European standards:

EN 55 022, class B

EN 61000-4-2, -4, -5, -6, -8, -9, -10, -11

The instruments are applicable for unlimited use in agricultural and industrial areas.

CONNECTION

Supply of energy from the main line has to be isolated from the measuring leads.



novotechnik

Siedle Group

Novotechnik Messwertaufnehmer OHG

Postfach 4220, 73745 Ostfildern (Ruit)

Horbstraße 12, 73760 Ostfildern (Ruit)

Telefon: +49 711 4489-0

Telefax: +49 711 4489-118

info@novotechnik.de

www.novotechnik.de



1.	Contents	3
2.	Instrument description	4
3.	Instrument connection	6
4.	Instrument setting	8
	Symbols used in the instructions	10
	Setting the DP and the (-) sign	10
	Control keys function	11
	Setting/permitting items into "USER" menu	11
5.	Setting "LIGHT" menu	12
5.0	Description "LIGHT" menu	12
	Setting input - Type "DC"	16
	Setting input - Type "PM"	18
	Setting input - Type "OHM"	20
	Setting input - Type "RTD - Pt"	22
	Setting input - Type "RTD - Ni"	24
	Setting input - Type "T/C"	26
	Setting input - Type "DU"	28
	Setting input - Type "RTD - Cu"	30
	Setting Limits	32
	Setting analog output	34
	Selection of programming menu „LIGHT"/„PROFI"	36
	Restoration of manufacture setting	36
	Calibration - input range (DU)	37
	Selection of instrument menu language version	38
	Setting new access password	38
	Instrument identification	39
6.	Setting "PROFI" menu	40
6.0	Description of "PROFI" menu	40
6.1	"PROFI" menu - INPUT	
6.1.1	Resetting internal values	42
6.1.2	Setting measuring type, range, mode, rate,	45
6.1.3	Setting the Real Time	49
6.1.4	External input function selection	49
6.1.5	Optional accessory functions of the keys	50
6.2	"PROFI" menu - CHANNEL	
6.2.1	Setting measuring parameters (projection, filters, decimal point, description)	54
6.2.2	Setting mathematic functions	58
6.2.3	Selection of evaluation of min/max. value	60
6.3	"PROFI" menu - OUTPUT	
6.3.1	Setting data logging	62
6.3.2	Setting Limits	64
6.3.3	Setting data output	67
6.3.4	Setting analog output	68
6.3.5	Selection of display projection	70
6.4	"PROFI" menu - SERVICE	
6.4.1	Selection of programming menu „LIGHT"/„PROFI"	72
6.4.2	Restoration manufacture setting	73
6.4.3	Calibration - input range (DU)	73
6.4.4	Selection of instrument menu language version	74
6.4.5	Setting new access password	74
6.4.6	Instrument identification	75
7.	Setting items into "USER" menu	76
7.0	Configuration "USER" menu	76
8.	Method of measuring of the cold junction	78
9.	Data protocol	80
10.	Error statements	82
11.	Table of symbols	83
12.	Technical data	84
13.	Instrument dimensions and instalation	86
14.	Certificate of guarantee	87

2.1 Description

The MAP 4000 model series are 4 digit panel programmable instruments designed for maximum efficiency and user comfort while maintaining their favourable price.

Type MAP 4000 is a multifunction instrument with the option of configuration for 8 various input options, easily configurable in the instrument menu. By further options of input modules it is feasible to measure larger ranges of DC voltage and current or increase the number of inputs up to 4 (applies for PM).

The instrument is based on an 8-bit microcontroller with a multichannel 24-bit sigma-delta converter, which secures high accuracy, stability and easy operation of the instrument.

The MAP 4000 is a multifunction instrument available in following types and ranges

type UNI

DC:	0...60/150/300/1200 mV
PM:	0...5 mA/0...20 mA/4...20 mA/±2 V/±5 V/±10 V/±40 V
OHM:	0...100 Ω/0...1 kΩ/0...10 kΩ/0...100 kΩ
RTD-Pt:	Pt 50/100/Pt 500/Pt 1 000
RTD-Cu:	Cu 50/Cu 100
RTD-Ni:	Ni 1 000/Ni 10 000
T/C:	J/K/T/E/B/S/R/N/L
DU:	Linear potentiometer (min. 500 Ω)

type UNI, option A

DC:	0...1 A/0...5 A/120 V/±250 V/±500 V
------------	-------------------------------------

type UNI, option B (expansion by 3 more inputs)

PM:	3x 0...5 mA/0...20 mA/4...20 mA/±2 V/±5 V/±10 V/±40 V
------------	---

PROGRAMMABLE PROJECTION

Selection:	of type of input and measuring range
Measuring range:	adjustable as fixed or with automatic change
Setting:	manual, optional projection on the display may be set in the menu for both limit values of the input signal, e.g. input 0...20 mA > 0...850,0
Projection:	-9999...9999 (-99999...999999)

COMPENSATION

of conduct:	in the menu it is possible to perform compensation for 2-wire connection
of conduct in probe:	internal connection (conduct resistance in measuring head)
of CJC (T/C):	manual or automatic, in the menu it is possible to perform selection of the type of thermocouple and compensation of cold junctions, which is adjustable or automatic (temperature at the brackets)

LINEARIZATION

Linearization:*	by linear interpolation in 50 points (solely via data)
-----------------	--

DIGITAL FILTERS

Exponen.average:	from 2...100 measurements
Rounding:	setting the projection step for display

MATHEMATIC FUCTIONS

Min/max. value:	registration of min./max. value reached during measurement
Tare:	designed to reset display upon non-zero input signal
Peak value:	the display shows only max. or min. value
Mat. operations:	polynome, 1/x, logarithm, exponential, power, root, sin x

EXTERNAL CONTROL

Lock:	control keys blocking
Hold:	display/instrument blocking
Tare:	tare activation/resetting tare to zero
Resetting MM:	resetting min/max value
Memory:	data storage into instrument memory

2.2 Operation

The instrument is set and controlled by five control keys located on the front panel. All programmable settings of the instrument are performed in three adjusting modes:

LIGHT Simple programming menu

- contains solely items necessary for instrument setting and is protected by optional number code

PROFI Complete programming menu

- contains complete instrument menu and is protected by optional number code

USER User programming menu

- may contain arbitrary items selected from the programming menu (LIGHT/PROFI), which determine the right (see or change)
- access without password

All programmable parameters are stored in the EEPROM memory (they hold even after the instrument is switched off).

2.3 Options

Excitation is suitable for supplying power to sensors and transmitters. It has a galvanic separation. The excitation can be adjusted with a small screwdriver in the range of 5..24V. Therefore, a small hole is located at the backside of the device (see Picture on page 7) above clamp No. 17 with an adjusting potentiometer behind.

Comparators are assigned to monitor one, two, three or four limit values with relay output. The user may select limits regime: LIMIT/DOSING/FROM-TO. The limits have adjustable hysteresis within the full range of the display as well as selectable delay of the switch-on in the range of 0..99,9 s. Reaching the preset limits is signalled by LED and simultaneously by the switch-on of the relevant relay.

Data outputs are for their rate and accuracy suitable for transmission of the measured data for further projection or directly into the control systems. We offer an isolated RS232 and RS485 with the ASCII or DIN MessBus protocol.

Analog outputs will find their place in applications where further evaluating or processing of measured data is required in external devices. We offer universal analog output with the option of selection of the type of output - voltage/current. The value of analog output corresponds with the displayed data and its type and range are selectable in Menu.

Measured data record is an internal time control of data collection. It is suitable where it is necessary to register measured values. Two modes may be used. FAST is designed for fast storage (40 records/s) of all measured values up to 8 000 records. Second mode is RTC, where data record is governed by Real Time with data storage in a selected time segment and cycle. Up to 250 000 values may be stored in the instrument memory. Data transmission into PC via serial interface RS232/485.

The instrument supply leads should not be in proximity of the incoming low-potential signals.

Contactors, motors with larger input power should not be in proximity of the instrument.

The leads into the instrument input (measured quantity) should be in sufficient distance from all power leads and appliances. Provided this cannot be secured it is necessary to use shielded leads with connection to ground (bracket E).

The instruments are tested in compliance with standards for use in industrial area, yet we recommend to abide by the above mentioned principles.

MEASURING RANGES

Type	Input I	Input U
DC		0...60/150/300/1 200 mV
PM	0...5/20 mA/4...20 mA	$\pm 2/\pm 5/\pm 10/\pm 40$ V
OHM	0...0,1/1/10/100 k Ω /Autorange	
RTD-Pt	Pt 100/Pt 500/ Pt 1 000	
RTD-Cu	Cu 50/100	
RTD-Ni	Ni 1 000/10 000	
T/C	J/K/T/E/B/S/R/N/L	
DU	Linear potentiometer (min. 500 Ω)	

OPTION "A"

Type	Input I	Input U
DC	$\pm 0,1$ A/ $\pm 0,25$ A/ $\pm 0,5$ A to GND (C) ± 2 A/ ± 5 A to GND (B)	± 100 V/ ± 250 V/ ± 500 V to GND (C)

OPTION "B"

Type	Input 2, 3, 4/I	Input 2, 3, 4/U
PM	0...5/20 mA/4...20 mA	$\pm 2/\pm 5/\pm 10/\pm 40$ V

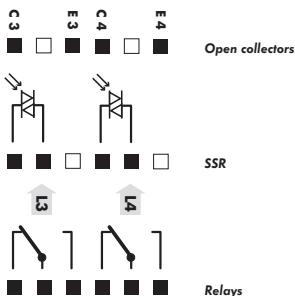

!
Excitation has the minus pole common with the input - the bracket no. 20 - GND and you may set its value by trimmer above the bracket no. 17

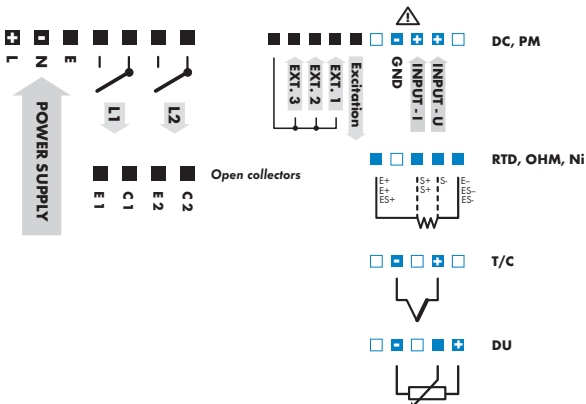
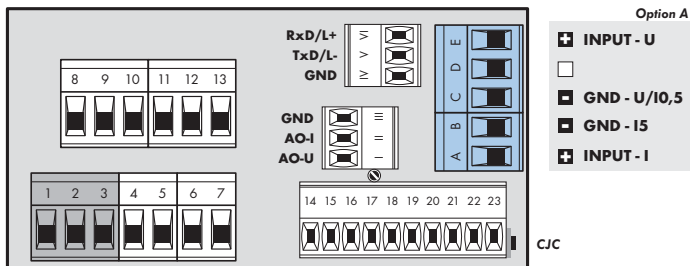

Maximum of 250 mA may be connected to "INPUT - I" (bracket no. 21) , i.e. 10-times range overload. Mind the correct connection/mistaking of current - voltage input. Destruction of measuring resistance in current input (15R) may occur.

PROFI

Setting

profi

- ▶ For expert users
- ▶ Complete instrument menu
- ▶ Access is password protected
- ▶ Possibility to arrange items of the „User“ menu
- ▶ Tree menu structure

LIGHT

Setting

light

- ▶ For trained users
- ▶ Only items necessary for instrument setting
- ▶ Access is password protected
- ▶ Possibility to arrange items of the „User“ menu
- ▶ Linear menu structure

USER

Setting

*profi light**user*

- ▶ For user operation
- ▶ Menu items are set by the user (Profi/Light) as per request
- ▶ Access is not password protected
- ▶ Optional menu structure either tree (PROFI) or linear (LIGHT)

4.1 Setting

The instrument is set and controlled by five control keys located on the front panel. All programmable settings of the instrument are performed in three adjusting modes:

- LIGHT** **Simple programming menu**
 - contains solely items necessary for instrument setting and is protected by optional number code
- PROFI** **Complete programming menu**
 - contains complete instrument menu and is protected by optional number code
- USER** **User programming menu**
 - may contain arbitrary items selected from the programming menu (LIGHT/PROFI), which determine the right (see or change)
 - access without password

All programmable parameters are stored in the EEPROM memory (they hold even after the instrument is switched off).

Scheme of processing the measured signal

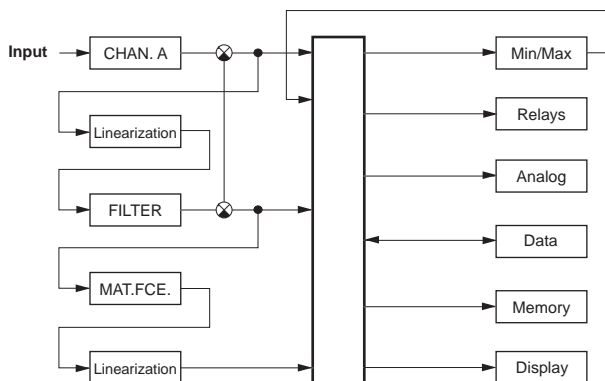

Setting and controlling the instrument is performed by means of 5 control keys located on the front panel. With the aid of these keys it is possible to browse through the operation menu and to select and set required values.

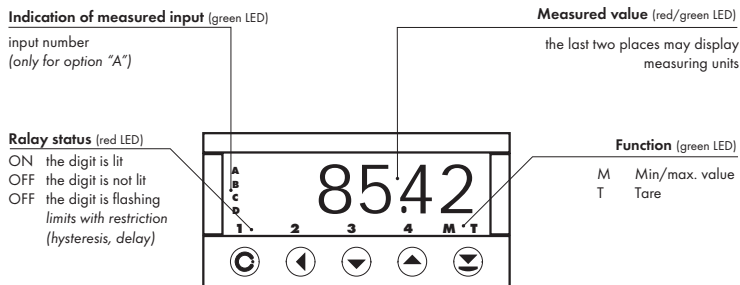

Symbols used in the instructions

DC **PM**
DU **OHM** **RTD** **T/C** Indicates the setting for given type of instrument

DEF values preset from manufacture

symbol indicates a flashing light (symbol)

inverted triangle indicates the item that can be placed in USER menu

broken line indicates a dynamic item, i.e. it is displayed only in particular selection/version

after pressing the key the set value will not be stored

after pressing the key the set value will be stored

30 continues on page 30

Setting the decimal point and the minus sign

DECIMAL POINT

Its selection in the menu, upon modification of the number to be adjusted it is performed by the control key with transition beyond the highest decade, when the decimal point starts flashing. Positioning is performed by / .

THE MINUS SIGN

Setting the minus sign is performed by the key on higher decade. When editing the item subtraction must be made from the current number (e.g.: 013 > , on class 100 > -87)

Control keys functions

Key	Measurement	Menu	Setting numbers/selection
	access into USER menu	exit menu	quit editing
	programmable key function	back to previous level	move to higher decade
	programmable key function	move to previous item	move down
	programmable key function	move to next item	move up
	programmable key function	confirm selection	confirm setting/selection
			numeric value is set to zero
	access into LIGHT/PROFI menu		
	direct access into PROFI menu		
		configuration of an item for "USER" menu	
		determine the sequence of items in "USER - LIGHT" menu	

Setting items into „USER“ menu

- in LIGHT or PROFI menu
- no items permitted in USER menu from manufacture
- on items marked by inverted triangle



Legend is flashing - current setting is displayed



- NO** item will not be displayed in USER menu
- YES** item will be displayed in USER menu with the option of setting
- SHOW** item will be solely displayed in USER menu

5.0

Setting "LIGHT"

LIGHT

Simple programming menu

- contains only items necessary for instrument setting and is protected by optional number code

SETTING LIGHT

light

- For capable users
- Only items necessary for instrument setting
- Access is password protected
- Possibility to arrange items of the „User“ menu
- Linear menu structure

Preset from manufacture

Password	"0"
Menu	LIGHT
USER menu	off
Setting the items	DEF

Access password
 1428 **PASSW.**

Type of instruments **TYPE** Measuring range **MODE**

RTD **OHM**
CONNEC. **FORM.A**

T/C
CONNEC. **CJTEM.** **FORM.A**

DC **PM** **OHM** **DU**
MIN.A **MAX.A** **FORM.A**

LIM.L1 **LIM.L2** **LIM.L3** **LIM.L4**

TYP.A0. **MIN.A0.** **MAX.A0.**

Menu type **MENU** Return to manufacture calibration **RE.CAL.** Return to manufacture setting **RE.SET.**

DU
C.MIN **C.MAX**

Language selection **LANG.** New password **PAS.LI.**

Identification **IDENT.** Type of instruments **MAP4000** SW: version **78-302** Input **PM** **Return to measuring mode**

!
 Upon delay exceeding 60 s the programming mode is automatically discontinued and the instrument itself restores the measuring mode

Selecting projection and connection

Option - comparator

Option - Analog output

Calibration - only for "DU"

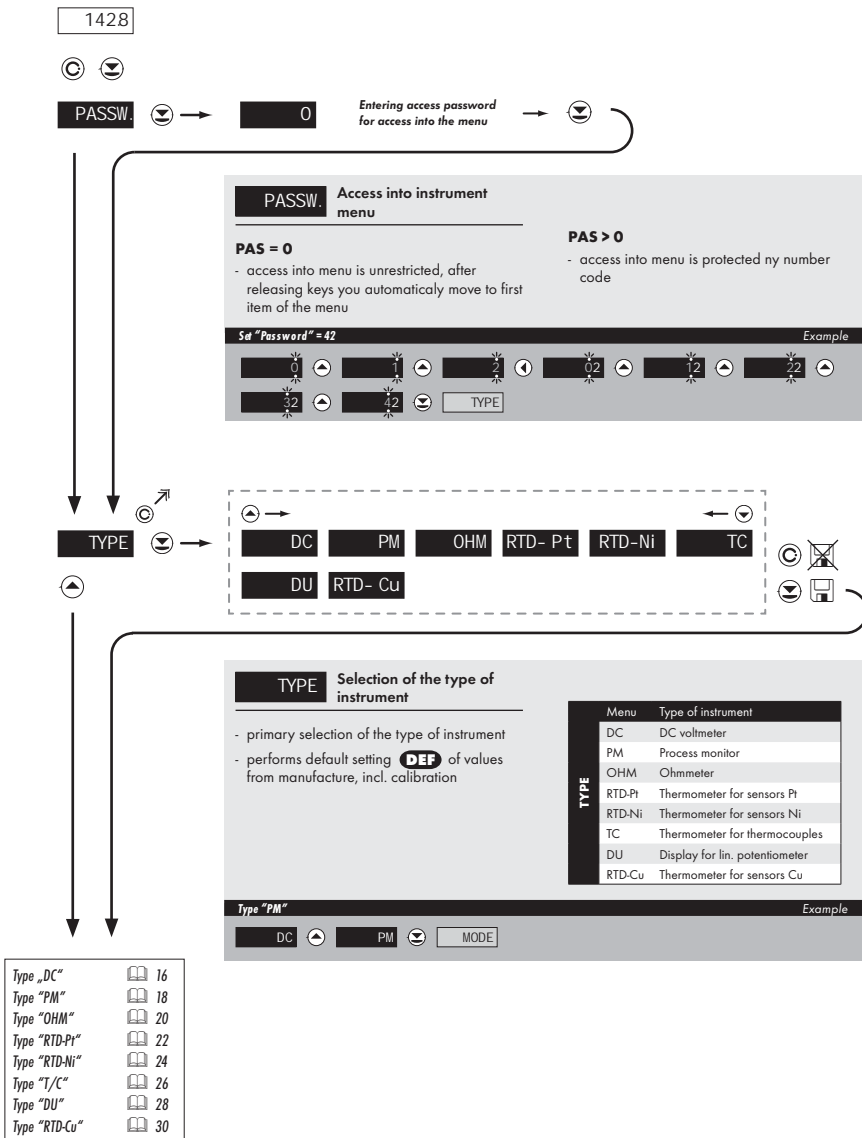

Type "DC"

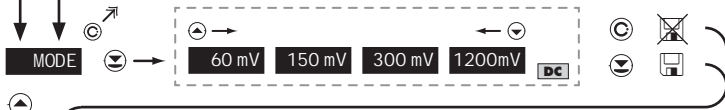

MODE Selection of the instrument measuring range

DEF = 60 mV

DEF = 500 V*

* only for option "A"

Menu	Measuring range
60 mV	±60 mV
150 mV	±150 mV
300 mV	±300 mV
1200mV	±1,2 V
100 V	±100 V
250 V	±250 V
500 V	±500 V
0.10 A	±0,1 A
0.25 A	±0,25 A
0.50 A	±0,5 A
1.00 A	±1 A
5.00 A	±5 A

Range ±150 mV Example

60 mV 150 mV MIN A



MIN A Setting display projection for minimum value of input signal

- position of the DP does not affect display projection
- the DP is automatically shifted after the value is confirmed

- range of the setting is -99999...999999

DEF = 0

Projection for 0 mV > MIN A = 0 Example

0 MAX A



MAX A Setting display projection for maximum value of input signal

- position of the DP does not affect display projection
- the DP is automatically shifted after the value is confirmed

- range of the setting is -99999...999999

DEF = 100

Projection for 150 mV > MAX A = 3500 Example

100	100	100	200	300	400
500	0500	1500	2500	3500	FORM.A

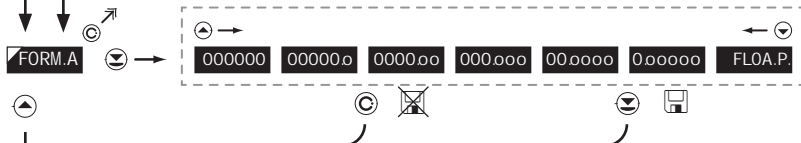

FORM.A Setting projection of the decimal point

DEF = 0000.00

- positioning of the DP is set here in the measuring mode

Projection of DP on display > 00000.0 Example

0000.00	00000.0	MENU
---------	---------	------

*subsequent item on the menu depends on instrument equipment

PM PM PM PM PM PM PM PM PM PM PM PM PM PM PM PM

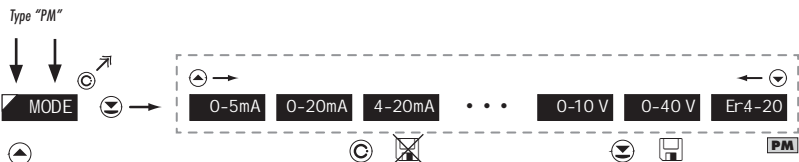

MODE Selection of the instrument measuring range

DEF = 4 - 20 mA

Menu	Range
0-5mA	0...5 mA
0-20mA	0...20 mA
4-20mA	4...20 mA
0.2 V	±2 V
0.5 V	±5 V
0-10 V	±10 V
0-40 V	±40 V
Er.4-20	4...20 mA, with error statement of „underfl ow“ upon signal smaller than 3,36 mA

Range 0...20 mA Example

4-20mA 0-20 mA MIN A

MIN A Setting for minimum input signal

0

Setting for minimum input signal

DEF = 0

MIN A Setting display projection for minimum value of input signal

- position of the DP does not affect display projection
- the DP is automatically shifted after the value is confirmed

- range of the setting is -99999...999999

DEF = 0

Projection for 0 mA > MIN A = -25 Example

0 1 2 3 4 5 0.5 1.5 2.5 3.5 4.5 5.5

0.5 1.5 2.5 3.5 4.5 5.5 MAX A



MAX A Setting display projection for maximum value of input signal

- position of the DP does not affect display projection
- the DP is automatically shifted after the value is confirmed

- range of the setting is -99999...999999

DEF = 100

Projection for 20 mA > MAX A = 2500 Example

100	100	100	200	300	400
500	0500	1500	2500	FORM A	

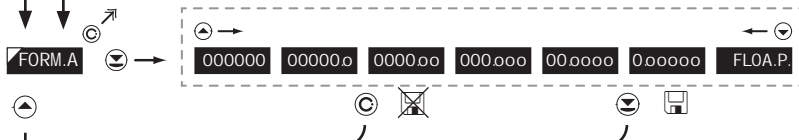

FORM.A Setting projection of the decimal point

DEF = 0000.00

- positioning of the DP is set here in the measuring mode

Projection of DP on display > 00000.0 Example

0000.00	00000.0	MENU
---------	---------	------

* subsequent item on the menu depends on instrument equipment

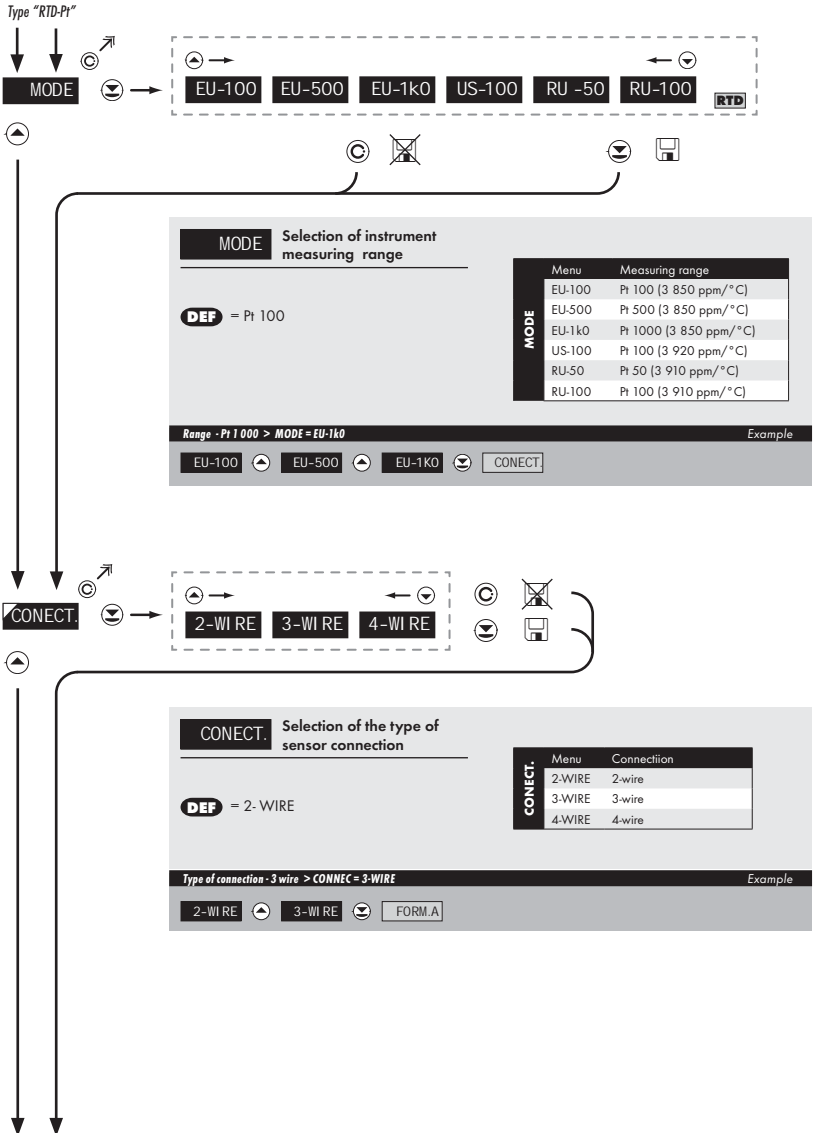



FORM.A

Setting projection of the decimal point

- positioning of the DP is set here in the measuring mode

DEF = 00000.0

Projection of DP on display > 000000

Example

00000.0

▼

000000

▼

MENU

* subsequent item on the menu depends on instrument equipment



32

RTD-Pt RTD-Pt RTD-Pt RTD-Pt RTD-Pt RTD-Pt RTD-Pt RTD-Pt

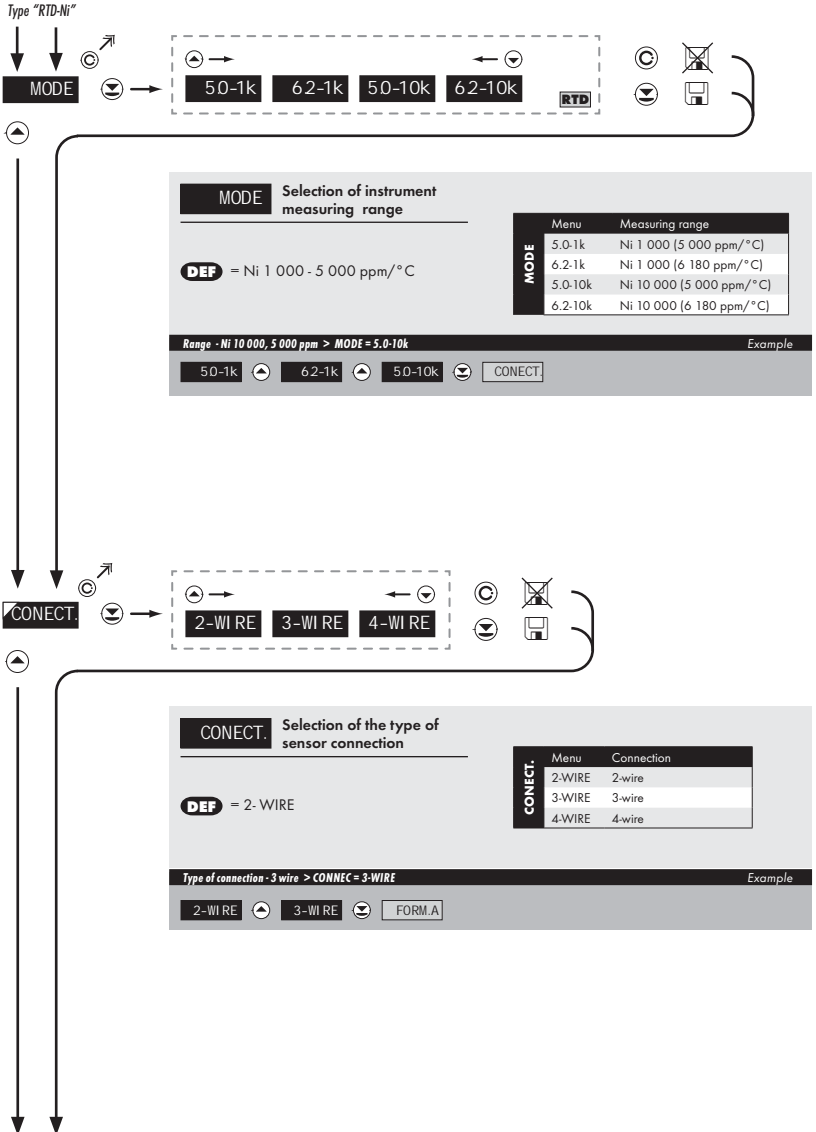



FORM.A Setting projection of the decimal point **DEF** = 00000.0

- positioning of the DP is set here in the measuring mode

Projection of DP on display > 000000 *Example*

00000.0	▼	000000	▼	MENU	*subsequent item on the menu depends on instrument equipment
---------	---	--------	---	------	--

32

T/C T/C T/C T/C T/C T/C T/C T/C T/C T/C T/C T/C T/C T/C T/C T/C

Type "T/C"

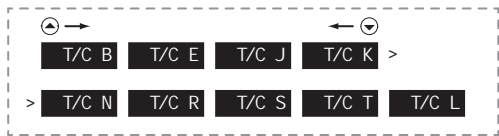
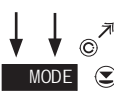

MODE Selection of the type of thermocouple

- setting the input range depends on the measuring range ordered

DEF = Type "J"

Menu	Type of thermocouple
T/C B	B
T/C E	E
T/C J	J
T/C K	K
T/C N	N
T/C R	R
T/C S	S
T/C T	T
T/C L	L

Type of thermocouple "K" Example

J [up] K [down] [CONNECT]



CONNECT Selection of the type of sensor connection

DEF = EXT. 1TC

Menu	Connection	Ref. T/C
INT.1TC	measuring C.J. at instrument brackets	x
INT.2TC	measuring C. J. at instrument brackets with anti-series connected ref. TC	✓
EXT.1TC	the entire measuring set is working under invaried and constant temperature	x
EXT.2TC	when using compensation box	✓

Type of connection > CONNECT. = EXT. 2TC Example

EXT1TC [up] EXT 2TC [down] [C.J. TEM]



C.J. TEM. Setting temperature of cold junction **DEF** = 23

- range 0...99 °C with compensation box

Setting temperature of cold junction > C.J. TEM. = 35 Example

23 24 25 25 35 **FORM.A**



FORM.A Setting projection of the decimal point **DEF** = 00000.0

- positioning of the DP is set here in the measuring mode

Projection of DP on display > 000000 Example

00000.0 000000 **MENU** * subsequent item on the menu depends on instrument equipment

!
For thermocouple type "B" the items **CONNECT.** and **C.J. TEM.** are not available

!
Method and procedure of setting the cold junctions is described in separate chapter on page 78

Type "DU"

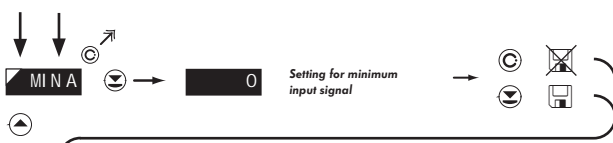

MIN A Setting display projection for minimum value of input signal

- position of the DP does not affect display projection
- the DP is automatically shifted after the value is confirmed

- range of the setting is -99999...999999

DEF = 0

Projection for the beginning > MIN A = 0 Example



MAX A Setting display projection for maximum value of input signal

- position of the DP does not affect display projection
- the DP is automatically shifted after the value is confirmed

- range of the setting is -99999...999999

DEF = 100

Projection for the end > MAX A = 5000 Example

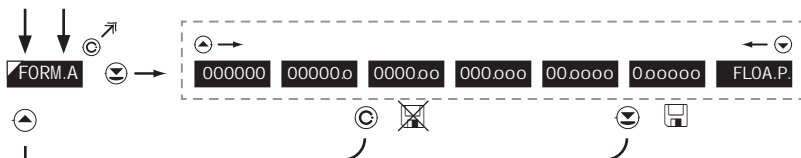

FORM.A Setting projection of the decimal point **DEF** = 0000.00

- positioning of the DP is set here in the measuring mode

Projection of DP on display > 0000.00 Example

0000.00 * subsequent item on the menu depends on instrument equipment



32

Calibration of the beginning and the end of range of linear potentiometer is on page 37



Type "RTD-Cu"



MODE Selection of instrument measuring range

DEF = Cu 50/4 280 ppm

Menu	Measuring range
428-50	Cu 50 (4 280 ppm/°C)
428-0.1	Cu 100 (4 280 ppm/°C)
426-50	Cu 50 (4 260 ppm/°C)
426-0.1	Cu 100 (4 260 ppm/°C)

Range - Cu 50/4 280 ppm > MODE = 426-50 Example

428-50 428-01 426-50 CONNECT

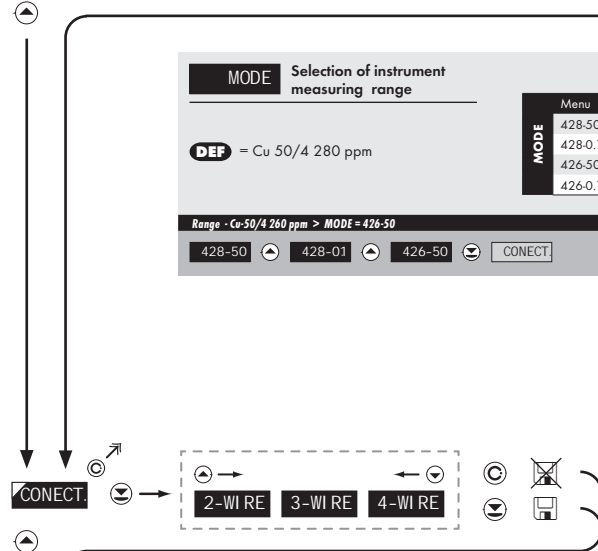

CONNECT. Selection of the type of sensor connection

DEF = 2-WIRE

Menu	Connection
2-WIRE	2-wire
3-WIRE	3-wire
4-WIRE	4-wire

Type of connection - 3 wire > CONNEC = 3-WIRE Example

2-WIRE 3-WIRE FORM.A



FORM.A Setting projection of the decimal point **DEF** = 00000.0

- positioning of the DP is set here in the measuring mode

Projection of DP on display > 000000 *Example*

00000.0	▼	000000	▼	MENU	<small>* subsequent item on the menu depends on instrument equipment</small>
---------	---	--------	---	------	--

32

RTD-Cu RTD-Cu RTD-Cu RTD-Cu RTD-Cu RTD-Cu RTD-Cu

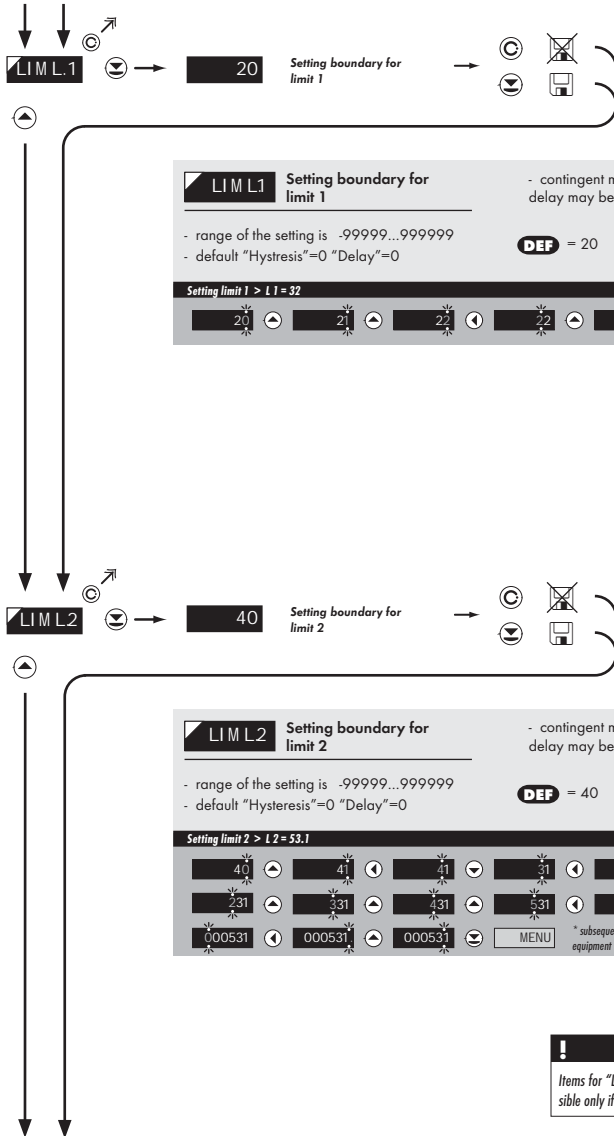



LIM L3 Setting boundary for limit 3

- range of the setting is -99999...999999
- default "Hysteresis"=0 "Delay"=0

DEF = 60

Setting limit 3 > L3 = 85 Example

60	61	62	63	64	65
65	75	85	MENU	* subsequent item on the menu depends on instrument equipment	



LIM L4 Setting boundary for limit 4

- range of the setting is -99999...999999
- default "Hysteresis"=0 "Delay"=0

DEF = 80

Setting limit 4 > L4 = 103 Example

80	81	82	83	83	93
03	003	103	MENU	* subsequent item on the menu depends on instrument equipment	

Diagram illustrating the settings for the analog output (A.O.) range and the display value for the beginning of the A.O. range.

Setting the type of analog output (TYP.A.O.):

The TYP.A.O. menu is shown with a range selection bar containing options: 0-20mA, E.4-20, 4-20mA, 0-5mA, 0-2 V, 0-5 V, and 0-10 V. The selected range is 4-20mA.

The TYP.A.O. menu displays the following table:

Menu	Range	Description
0-20mA	0...20 mA	
E. 4-20mA	4...20 mA	with indication of error statement (<3,6 mA)
4-20mA	4...20 mA	
0.5mA	0...5 mA	
0.2 V	0...2 V	
0.5 V	0...5 V	
0-10 V	0...10 V	

The DEF value is 4...20 mA.

The example shows the Type of analog output - 0...10 V > TYP.A.O. = 0-10 V. The selected range is 4-20mA.

Assigning the display value to the beginning of the AO range (MIN A.O.):

The MIN A.O. menu is shown with a display value of 0. The text indicates: "Assigning the display value to the beginning of the AO range".

The MIN A.O. menu displays the following information:

DEF = 0

- range of the setting is -99999...99999

The example shows the Display value for the beginning of the AO range > MIN A.O. = 0. The selected value is 0.

Warning: Items for "Limits" and "Analog output" are accessible only if incorporated in the instrument.

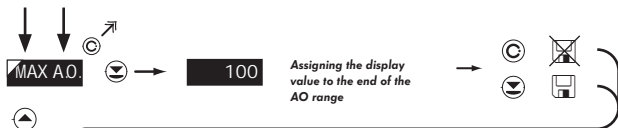

MAX A.O. Assigning the display value to the end of the AO range **DEF** = 100

- range of the setting is -99999...999999

Display value for the end of the AO range > MAX A.O. = 120 Example

100 100 110 120 MENU

Displayed only with options > **Analog output**

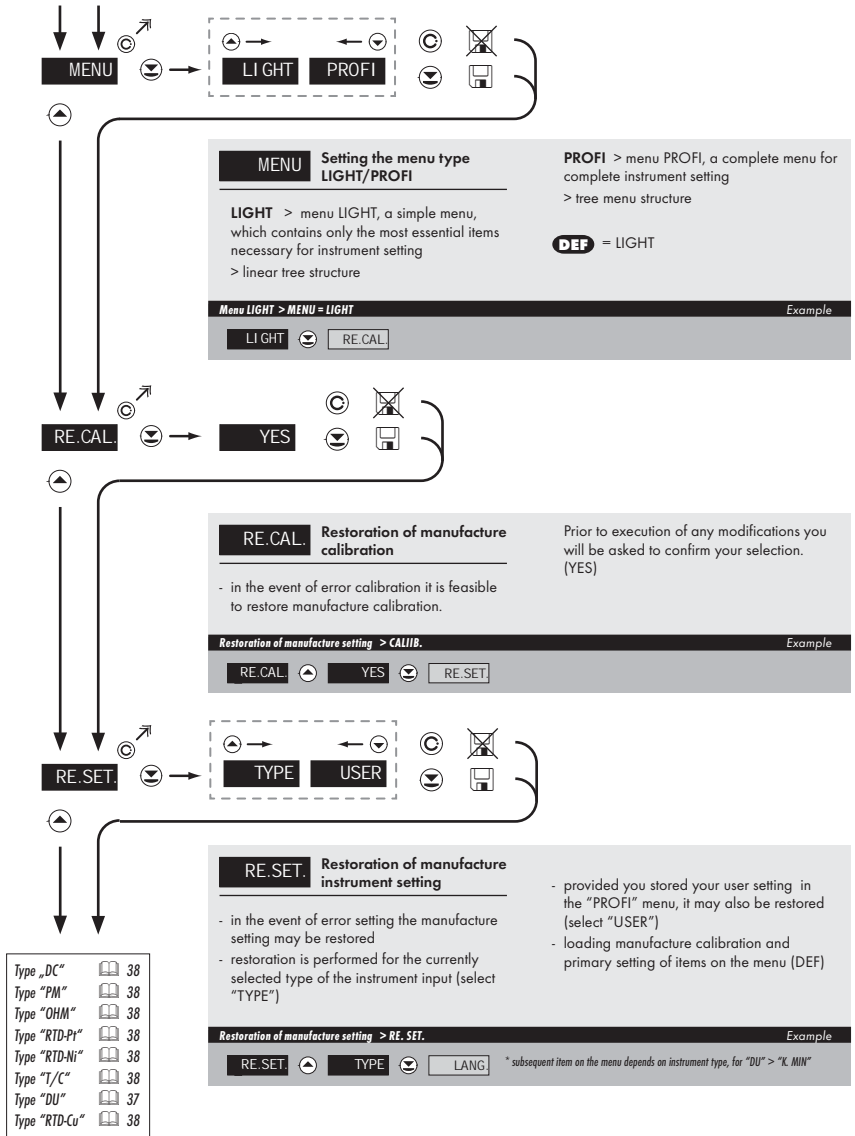

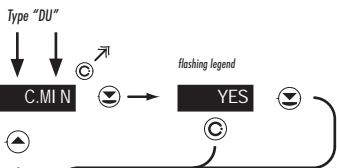

C.MI N Calibration of input range - the potentiometer traveller in initial position Only for type "DU"

- prior confirming the flashing "YES" sign the potentiometer traveller has to be in given idle position

Calibration of the beginning of the range > C. MIN Example

YES (with flashing legend icon)

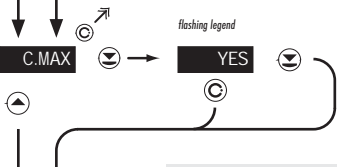

C.MAX Calibration of input range - the potentiometer traveller in end position Only for type "DU"

- prior confirming the flashing "YES" sign the potentiometer traveller has to be in given idle position

Calibration of the end of the range > C. MAX Example

YES (with flashing legend icon)



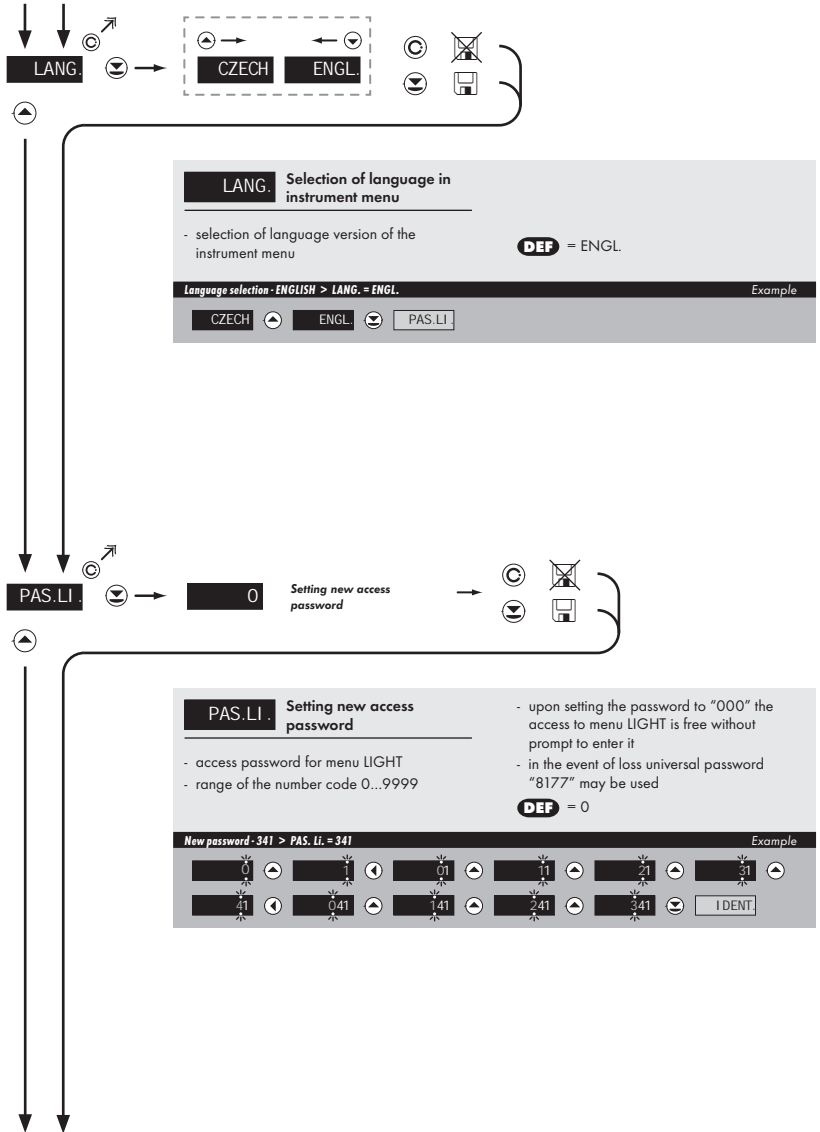

LANG. Selection of language in instrument menu

- selection of language version of the instrument menu **DEP** = ENGL.

Language selection - ENGLISH > LANG. = ENGL. Example

CZECH ENGL. PAS.LI

PAS.LI. Setting new access password

- upon setting the password to "000" the access to menu LIGHT is free without prompt to enter it
 - in the event of loss universal password "8177" may be used **DEP** = 0

New password - 341 > PAS. Li. = 341 Example

0	1	01	11	21	31
1	01	11	21	31	IDENT

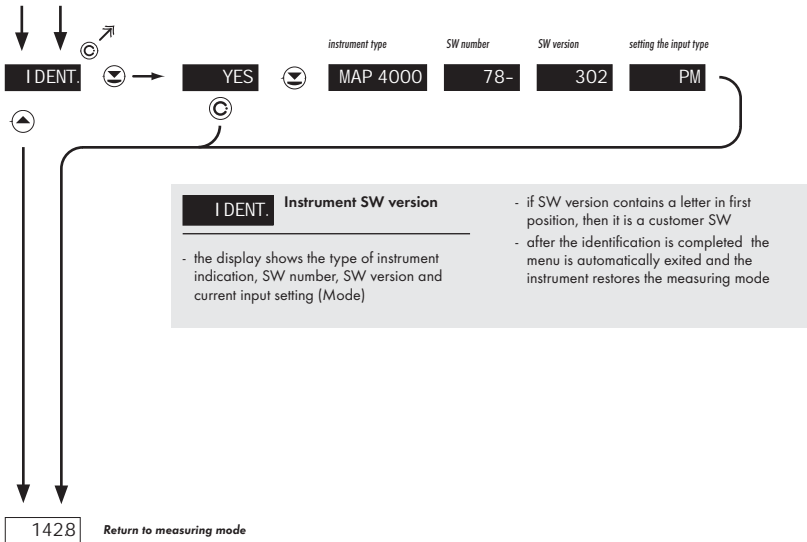

6.0

Setting "PROFI"

PROFI

Complete programming menu

- contains complete instrument menu and is protected by optional number code
- designed for expert users
- preset from manufacture is menu **LIGHT**

 SETTING
 PROFI
 

- For expert users
- Complete instrument menu
- Access is password protected
- Possibility to arrange items of the „User“ menu
- Tree menu structure

Switching over to "PROFI" menu



- temporary switch-over to **PROFI** menu, which is suitable to edit a few items
- after quitting **PROFI** menu the instrument automatically switches to **LIGHT** menu
- access is password protected (if it was not set under item N. PASS. =0)



- access into **LIGHT** menu and transition to item „MENU“ with subsequent selection of „PROFI“ and confirmation
- after re-entering the menu the **PROFI** type is active
- access is password protected (if it was not set under item N. PASS. =0)

6.1 Setting "PROFI" - INPUT

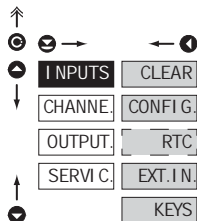

The primary instrument parameters are set in this menu

CLEAR	Resetting internal values
CONFIG.	Selection of measuring range and parameters
RTC	Setting date and time for option with RTC
EXT.IN.	Setting external inputs functions
KEYS	Assigning further functions to keys on the instrument

6.1.1 Resetting internal values

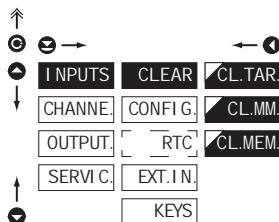

CLEAR	Resetting internal values
CL.TAR.	Tare resetting
CL.MM.	Resetting min/max value
CL.MEM.	Resetting the instrument memory

- resetting memory for the storage of minimum and maximum value achieved during measurement
- resetting memory with data measured in the "FAST" or "RTC" modes
- not in standard equipment

6.1.2a Selection of measuring rate

INPUTS	CLEAR	READ/S	40.0
CHANNE	CONF I G	TYPE	20.0
OUTPUT	RTC	MODE	10.0
SERVIC	EXT. I N	CONNECT	5.0
	KEYS	C.J. TEM	20
		AD.RES	10
		LEADS	05
			02
			01

DEF

READ/S	Selection of measuring rate
40.0	40,0 measurements/s
20.0	20,0 measurements/s
10.0	10,0 measurements/s
5.0	5,0 measurements/s
2.0	2,0 measurements/s
1.0	1,0 measurement/s
0.5	0,5 measurements/s
0.2	0,2 measurements/s
0.1	0,1 measurements/s

6.1.2b Selection of „instrument“ type

INPUTS	CLEAR	READ/S	DC
CHANNE	CONF I G	TYPE	PM
OUTPUT	RTC	MODE	OHM
SERVIC	EXT. I N	CONNECT	RTD-Pt
	KEYS	C.J. TEM	RTD-Ni
		AD.RES	TC
		LEADS	DU
			RTD-Cu

DEF

TYPE	Selection of „instrument“ type
DC	DC voltmeter
PM	Process monitor
OHM	Ohmmeter
RTD-Pt	Thermometer for Pt xxx
RTD-Ni	Thermometer for Ni xxxx
TC	Thermometer pro thermocouples
DU	Display for linear potentiometers
RTD-Cu	Thermometer for Cu xxx

- selection of particular type of "instrument" is bound to relevant dynamic items

1428 + PASSW 0 Access password

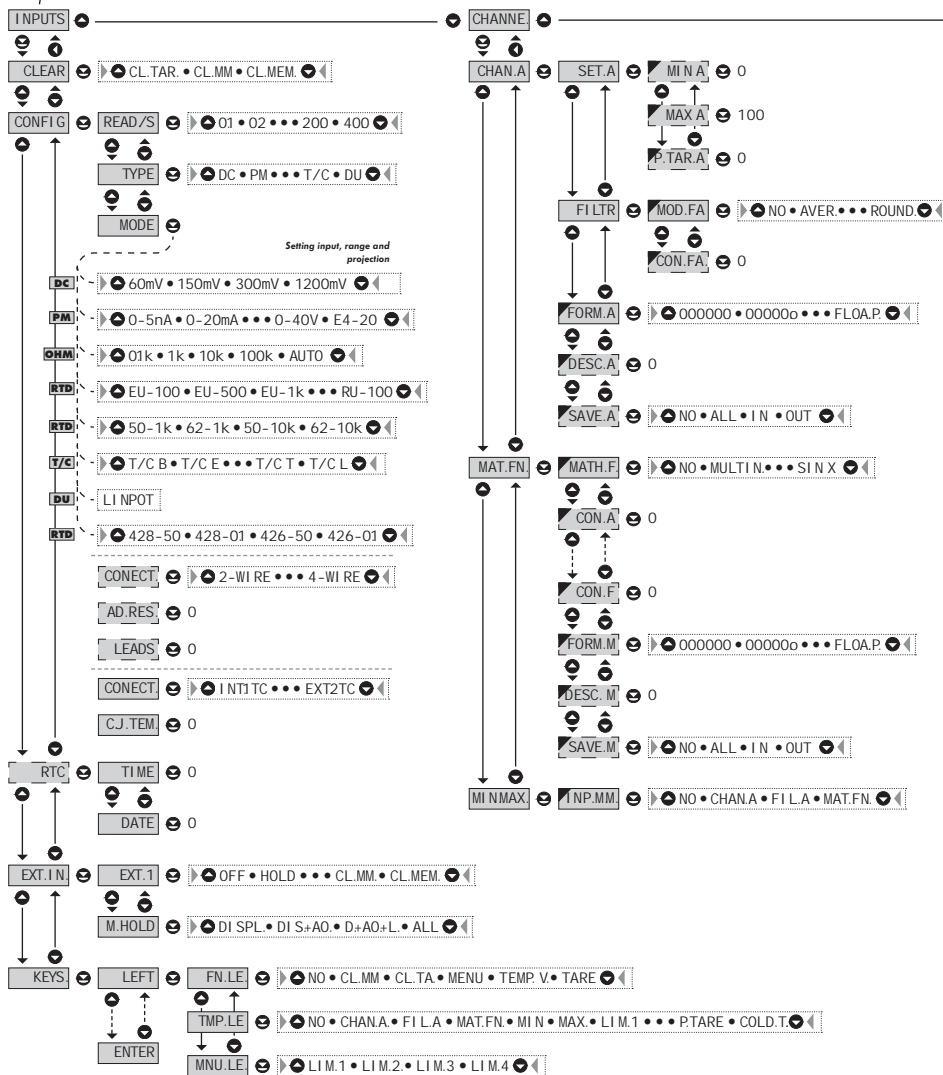

NAME PROFI MENU

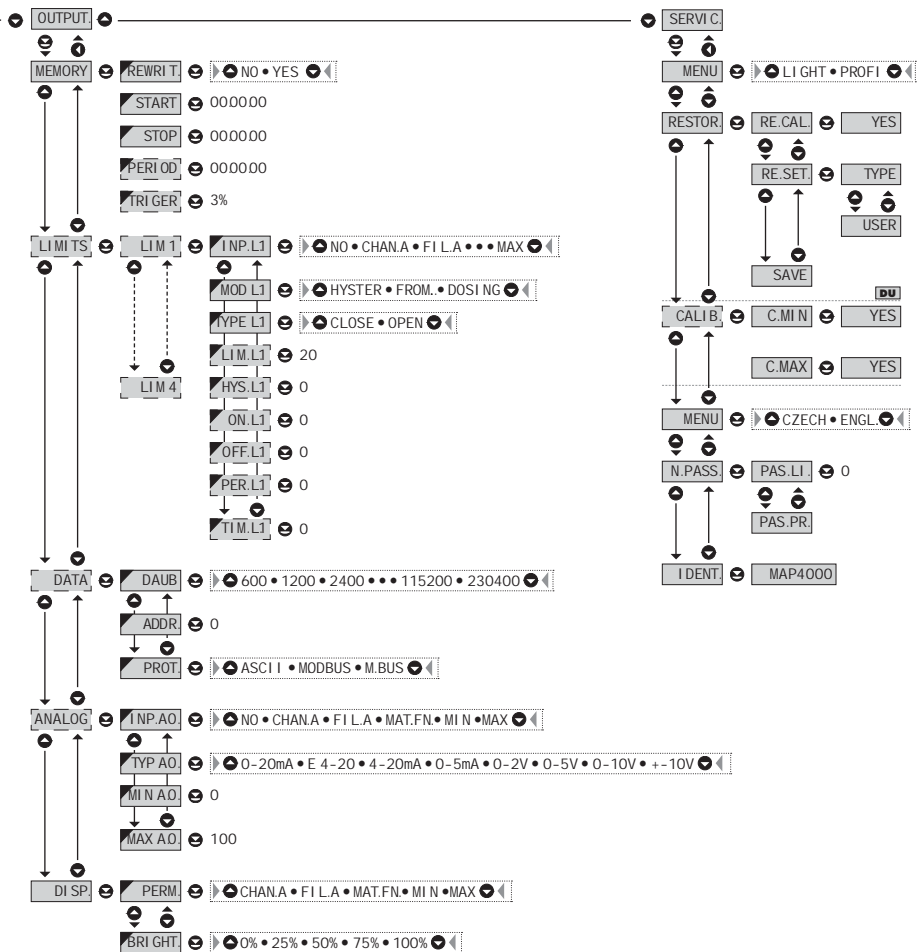

!
 Upon delay exceeding 60 s the programming mode is automatically discontinued and the instrument itself restores the measuring mode

6.1.2c Selection of measuring range

↑

⊙ →

⬆

⬆

DC

OHM ← 1

DEF

INPUTS	CLEAR	READ/S	60mV	100 R
CHANNE	CONF1 G.	TYPE	150mV	1 k
OUTPUT	RTC	MODE	300mV	10 k
SERVI C.	EXT. I.N.	CONNECT	1200mV	100 k
	KEYS	C.J. TEM		AUTO
		AD. RES		
		LEADS		

DC - A

PM

DEF

100 V	0-5mA
250 V	0-20mA
DEF 500 V	DEF 4-20mA
010 A	0-2 V
025 A	0-5 V
050 A	0-10 V
100 A	0-40 V
500 A	Er4-20

DEF

RTD-Pt

RTD-Cu

DEF

EU-100	428-50
EU-500	428-01
EU-1k0	426-50
US-100	426-01
RU-50	
RU-100	

DEF

T/C

RTD-Ni

T/C B

T/C E

T/C J

T/C K

T/C N

T/C R

T/C S

T/C T

T/C L

DEF

DU

DEF

LI NPOT.	T/C L
----------	-------

! Switching in the mode AUTO - "OHM"

0.1 > 1 k	0.101 k
1 k > 10 k	1.010 k
10 k > 100 k	10.10 k
100 > 10 k	9.900 k
10 k > 1 k	0.990 k
1 k > 0.1 k	0.099 k

When selecting the "AUTO" range, the items "MIN", "MAX", "P. TAR. A" will not be displayed in the "CHAN. A" setting

↑

⊙

MODE Selection of instrument measuring range

MODE	Measuring range
DC	60 mV ±60 mV
	150 mV ±150 mV
	300 mV ±300 mV
	1200mV ±1.2 V
DC - A	100 V ±100 V
	250 V ±250 V
	500 V ±500 V
	0.10 A ±0.1 A
	0.25 A ±0.25 A
	0.50 A ±0.5 A
	1.00 A ±1 A
5.00 A ±5 A	
PM	Menu Measuring range
	0-5mA 0..5 mA
	0-20mA 0..20 mA
	4-20mA 4..20 mA
	0-2 V ±2 V
	0-5 V ±5 V
	0-10 V ±10 V
	0-40 V ±40 V
Er4-20 4..20 mA, with error statement of „underfl ow“ upon signal smaller than 3.36 mA	
OHM	Menu Measuring range
	100 R 0..100 Ω
	1 k 0..1 kΩ
	10 k 0..10 kΩ
AUTO Autorange	
RTD-Pt	Menu Measuring range
	EU-100 Pt 100 (3 850 ppm/°C)
	EU-500 Pt 500 (3 850 ppm/°C)
	EU-1k0 Pt 1000 (3 850 ppm/°C)
	US-100 Pt 100 (3 920 ppm/°C)
	RU-50 Pt 50 (3 910 ppm/°C)
RU-100 Pt 100 (3 910 ppm/°C)	
RTD-Ni	Menu Measuring range
	5.0-1k Ni 1 000 (5 000 ppm/°C)
	6.2-1k Ni 1 000 (6 180 ppm/°C)
	5.0-10k Ni 10 000 (5 000 ppm/°C)
6.2-10k Ni 10 000 (6 180 ppm/°C)	
RTD-Cu	Menu Measuring range
	428-50 Cu 50 (4 280 ppm/°C)
	428-0.1 Cu 1 00 (4 280 ppm/°C)
	426-50 Cu 50 (4 260 ppm/°C)
	426-0.1 Cu 100 (4 260 ppm/°C)
T/C	Menu Type of thermocouple
	T/C B B
	T/C E E
	T/C J J
	T/C K K
	T/C N N
	T/C R R
	T/C S S
	T/C T T
	T/C L L

6.1.2d Selection of type of sensor connection

RTD **OHM** **T/C**

↑
 Ⓞ →
 ↕
 Ⓞ ← ①
 INPUTS CLEAR READ/S 2-WI RE **DEF**
 CHANNE CONF I G TYPE 3-WI RE
 OUTPUT _RTC_ MODE 4-WI RE
 SERVI C EXT. I N CONECT.
 KEYS AD.RES.
 LEADS

↑
 Ⓞ →
 ↕
 Ⓞ ← ①
 INPUTS CLEAR READ/S INT1TC
 CHANNE CONF I G TYPE INT2TC **DEF**
 OUTPUT _RTC_ MODE EXT1TC
 SERVI C EXT. I N CONECT. EXT2TC
 KEYS C.J. TEM.

CONNECT. Selection of type of sensor connection

RTD **OHM**

2-WI RE 2-wire connection

3-WI RE 3-wire connection

4-WI RE 4-wire connection

T/C

INT.1TC Measurement without reference thermocouple
 - measuring cold junction at instrument brackets

INT.2TC Measurement with reference thermocouple
 - measuring cold junction at instrument brackets with anti-series connected reference thermocouple

EXT1TC Measurement without reference thermocouple
 - the entire measuring set is working under invaried and constant temperature

EXT2TC Measurement with reference thermocouple
 - when using compensation box



Method and procedure of setting the cold junctions is described in separate chapter on page 78



For thermocouple type "B" the items CONECT. and C.J. TEM. are not available

6.1.2e Setting temperature of cold junction

T/C

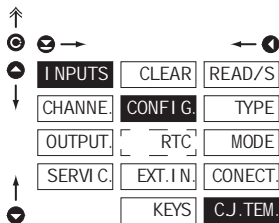
**C.J. TEM.** Setting temperature of cold junction

- range 0...99 °C with compensation box
- **DEF** = 23 °C

6.1.2f Offset of the beginning of the measuring range

RTD OHM

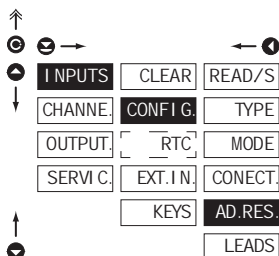
**AD.RES.** Offset of the beginning of the measuring range

- in cases when it is necessary to offset the beginning of the range by certain value, e.g. while using sensor in measuring head
- entered directly in Ohm (0...9999)
- **DEF** = 0

6.1.2g Compensation of 2-wire conduct

RTD OHM

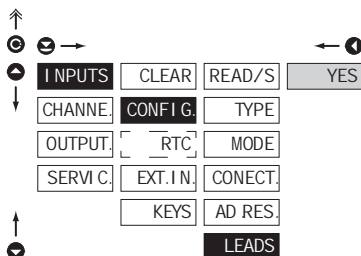
**LEADS** Compensation of 2-wire conduct

- for measurement accuracy it is necessary to perform compensation of conduct always in case of 2-wire connection
- prior confirmation of the displayed prompt „YES“ it is necessary to substitute the sensor at the end of the conduct by a short-circuit
- **DEF** = 0

6.1.3 Setting the real time clock

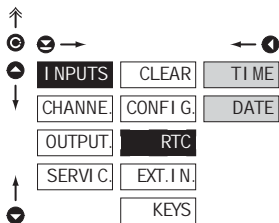

RTC Setting the real time clock (RTC)

TIME Time setting

- format 23.59.59

DATE Date setting

- format DD.MM.YY

6.1.4a External input function selection

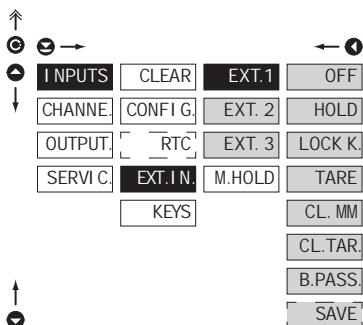

EXT. I.N. External input function selection

OFF Input is off

HOLD Activation of HOLD

LOCK K. Locking keys on the instrument

TARE Tare activation

CL.MM Resetting min/max value

CL.TAR. Tare resetting

B.PASS. Activation of locking access into programming menu LIGHT/PROFI

SAVE Activation of measured data record in instrument memory (not in standard equipment)

- **DEF** EXT. 1 > HOLD

- **DEF** EXT. 2 > LOCK K.

- **DEF** EXT. 3 > TARE

*

Setting procedure is identical for EXT. 2 and EXT. 3

6.1.4b Selection of function "HOLD"

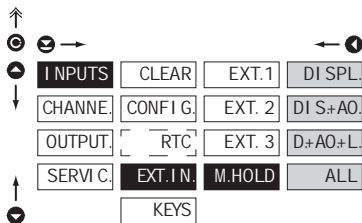

M.HOLD Selection of function "HOLD"

- | | |
|----------|--|
| DI SPL. | "HOLD" locks only the value displayed |
| DI S+AO. | "HOLD" locks the value displayed and on AO |
| D+AO+L. | "HOLD" locks the value displayed, on AO and limit evaluation |
| ALL | "HOLD" locks the entire instrument |

6.1.5a Optional accessory functions of the keys

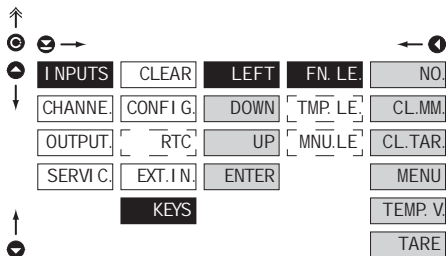

FN. LE. Assigning further functions to instrument keys

- „FN. LE.“ > executive functions
- „TMP. LE.“ > temporary projection of selected values
- „MNU. LE.“ > direct access into menu on selected item

- | | |
|----------|--|
| NO. | Key has no further function |
| CL.MM. | Resetting min/max value |
| CL.TAR. | Tare resetting |
| MENU | Direct access into menu on selected item |
| TEMP. V. | Temporary projection of selected values |
| TARE | Tare function activation |

!

Preset values of the control keys **DEF.**

LEFT	Show Tare
UP	Show Max. value
DOWN	Show Min. value
ENTER	Tare

!

Setting is identical for LEFT, DOWN, UP and ENTER

6.1.5b Optional accessory functions of the keys - Temporary projection

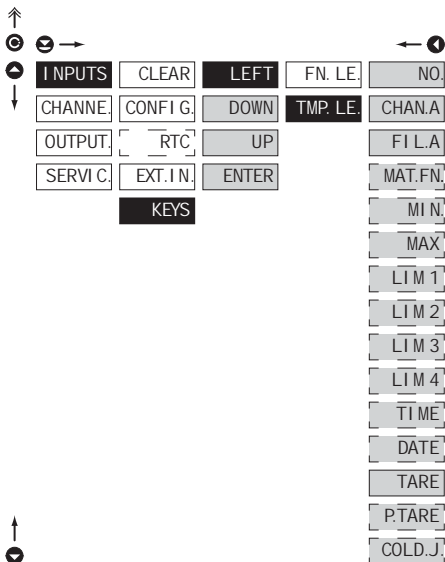

TMP. LE. Temporary projection of selected item

- "Temporary" projection of selected value is displayed for the time of keystroke
- "Temporary" projection may be switched to permanent by pressing **C** + "Selected key", this holds until the stroke of any key

NO	Temporary projection is off
CHAN. A.	Temporary projection of "Channel A" value
FIL. A.	Temporary projection of "Channel A" value after processing digital filters
MAT. FN.	Temporary projection of "Mathematic functions" value
MIN	Temporary projection of "Min. value"
MAX	Temporary projection of "Max. value"
LIM 1	Temporary projection of "Limit 1" value
LIM 2	Temporary projection of "Limit 2" value
LIM 3	Temporary projection of "Limit 3" value
LIM 4	Temporary projection of "Limit 4" value
TIME	Temporary projection of "TIME" value
DATE	Temporary projection of "DATE" value
TARE	Temporary projection of "TARE" value
P. TARE	Temporary projection of "P. TARE" value
COLD. J.	Temporary projection of "CJC" value

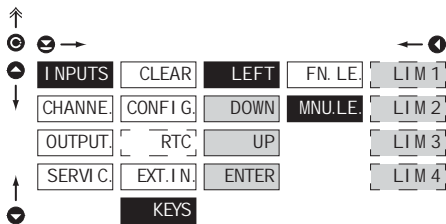

Setting is identical for **LEFT**, **DOWN**, **UP** and **ENTER**

6.1.5c Optional accessory functions of the keys - Direct access to item

MNU. LE. Assigning access to selected menu item

- LIM 1** Direct access to item "LIM 1"
- LIM 2** Direct access to item "LIM 2"
- LIM 3** Direct access to item "LIM 3"
- LIM 4** Direct access to item "LIM 4"

!
Setting is identical for LEFT, DOWN, UP and ENTER

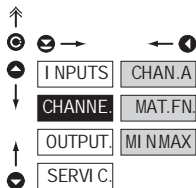
6.2 Setting "PROFI" - CHANNELS



The primary instrument parameters are set in this menu

CHAN. A	Setting parameters of measuring "Channel"
MAT. FN.	Setting parameters of mathematic functions
MI NMAX	Selection of access and evaluation of Min/max value

6.2.1 a Display projection

DC PM DU OHM

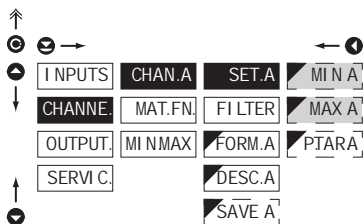

SET. A Setting display projection

MI N A Setting display projection for minimum value of input signal
 - range of the setting is -99999...999999
 - **DEF** = 0

MAX A Setting display projection for maximum value of input signal
 - range of the setting is -99999...999999
 - **DEF** = 100

6.2.1 b Setting fixed tare

DC PM DU OHM

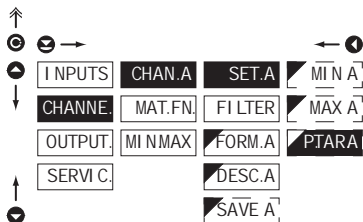

P. TAR. A Setting "Fixed tare" value

- setting is designed for the event when it is necessary to firmly shift the beginning of the range by known size
- when setting (P. TAR. A > 0) display shows "T" symbol
- range of the setting is 0...999999
- **DEF** = 0

6.2.1 c Digital filters

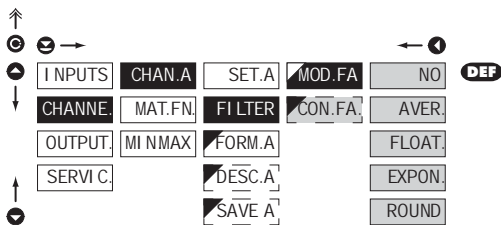

MOD.FA Selection of digital filters

- at times it is useful for better user projection of data on display to modify it mathematically and properly, wherefore the following filters may be used:

NO Filters are off

AVER. Measured data average

- arithmetic average from given number („CON.F.A.“) of measured values
- range 2...100

FLOAT. Selection of floating filter

- floating arithmetic average from given number („CON.F.A.“) of measured data and updates with each measured value
- range 2...30

EXPON. Selection of exponential filter

- integration filter of first prvnho grade with time constant („CON.F.A.“) measurement
- range 2...100

ROUND Measured value rounding

- is entered by any number, which determines the projection step (e.g: „CON.F.A.“=2,5 > display 0, 2.5, 5,...)

CON.F.A. Setting constants

- this menu item is always displayed after selection of particular type of filter
- **DEF** = 2

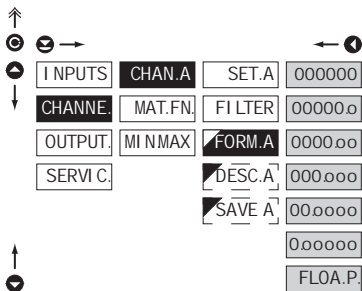
6.2.1d Projection format - positioning of decimal point

FORM. A Selection of decimal point

- the instrument allows for classic projection of a number with positioning of the DP as well as projection with floating DP, allowing to display a number in its most exact form „FLOA.T.P.“

000000. Setting DP - XXXXX.

00000.0 Setting DP - XXXXX.x

- **DEF** > **RTD** **T/C**

0000.00 Setting DP - XXXX.xx

- **DEF** > **DC** **PM** **DU** **OHM**

000.000 Setting DP - XXX.xxx

00.0000 Setting DP - XX.xxxx

0.00000 Setting DP - X.xxxxx

FLOA.P. Floating DP

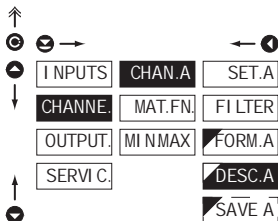
6.2.1e Projection of description - the measuring units

DESC. A Setting projection of description for "Channel A"

- projection of measured data may be extended (at the expense of the number of displayed places) by two characters for description
- description is set by shifted ASCII code, when two first places show the set description and two last characters their code in period 0...95
- description is cancelled by code 00
- **RTD** **T/C** **DEF** = °C
- **DC** **PM** **DU** **OHM** **DEF** = none

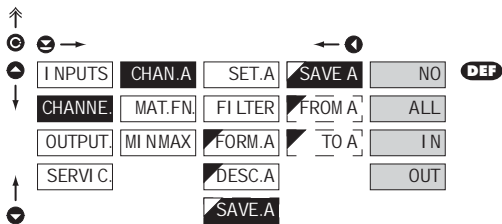

Table of signs on page 83

6.2.1f Selection of storing data into instrument memory



SAVE.A Selection of storing data into instrument memory

- by selection in this item you allow to register values into instrument memory
- another setting in item "OUTPUT. > MEMORY" (not in standard experiment)

- NO Measured data is not stored
- ALL Measured data is stored in memory
- IN Only data measured within the set interval is stored in memory
- OUT Only data measured outside the set interval is stored in memory

FROM A Setting the initial interval value

- setting range: -99999...999999

TO A Setting the final interval value

- setting range: -99999...999999

6.2.2a Mathematic functions

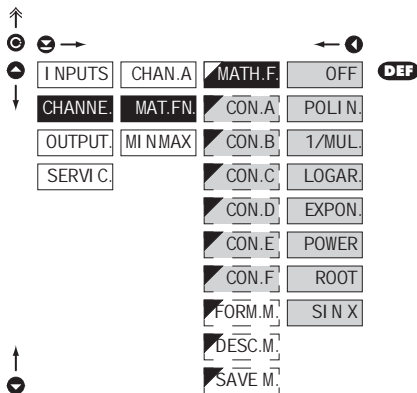
MATH.F. Selection of mathematic functions

OFF

Mathematic functions are off

POLI.N.

Polynome

$$Ax^2 + Bx^1 + Cx^0 + Dx^3 + Ex + F$$

1/MUL.

1/x

$$\frac{A}{x^3} + \frac{B}{x^4} + \frac{C}{x^2} + \frac{D}{x^2} + \frac{E}{x} + F$$

LOGAR.

Logarithm

$$A \times \ln\left(\frac{Bx+C}{Dx+E}\right) + F$$

EXPON.

Exponential

$$A \times e^{\left(\frac{Bx+C}{Dx+E}\right)} + F$$

POWER

Power

$$A \times (Bx+C)^{(Dx+E)} + F$$

ROOT

Root

$$A \times \sqrt{\frac{Bx+C}{Dx+E}} + F$$

SIN X

Sin x

$$A \sin^5 x + B \sin^4 x + C \sin^3 x + D \sin^2 x + E \sin x + F$$

CON.-

Setting constants for calculation of mat. functions

- this menu is displayed only after selection of given mathematic function

6.2.2b Mathematic functions - decimal point

INPUTS	CHAN.A	MATH.F	000000
CHANNE.	MAT.FN	CON.A	00000.0
OUTPUT	MI NMAX	CON.B	0000.00
SERVI.C		CON.C	000.000
		CON.D	00.0000
		CON.E	0.00000
		CON.F	FLOA.P
		FORM.M	DEF
		DESC.M	
		SAVE M	

FORM.M. Selection of decimal point

- the instrument allows for classic projection of a number with positioning of the DP as well as projection with floating DP, allowing to display a number in its most exact form „FLOA.P.“

- | | |
|---------|----------------------|
| 000000. | Setting DP - XXXXXX. |
| 00000.0 | Setting DP - XXXXX.x |
| 0000.00 | Setting DP - XXXX.xx |
| 000.000 | Setting DP - XXX.xxx |
| 00.0000 | Setting DP - XX.xxxx |
| 0.00000 | Setting DP - X.xxxxx |
| FLOA.P. | Floating DP |

- **DEF**

6.2.2c Mathematic functions - measuring units

INPUTS	CHAN.A	MATH.F
CHANNE.	MAT.FN	CON.A
OUTPUT	MI NMAX	CON.B
SERVI.C		CON.C
		CON.D
		CON.E
		CON.F
		FORM.M
		DESC.M
		SAVE M

DESC.M. Setting projection of description for "MAT.FN"

- projection of measured data may be extended (at the expense of the number of displayed places) by two characters for description
- description is set by shifted ASCII code, when two first places show the set description and two last characters their code in period 0...95
- description is cancelled by code 00

- **DEF** = no description

! Table of signs on page 83

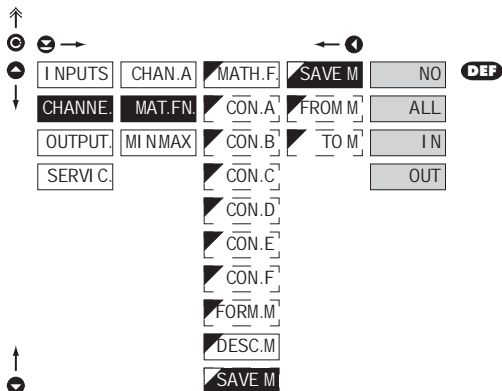
6.2.2d **Mathematic functions - selection of storing data into instrument memory**

SAVE M Selection of storing data into instrument memory

- by selection in this item you allow to register values into instrument memory
- another setting in item "OUTPUT. > MEMORY" (not in standard experiment)

- NO** Measured data is not stored
- ALL** Measured data is stored in memory
- IN** Only data measured within the set interval is stored in memory
- OUT** Only data measured outside the set interval is stored in memory

FROM M Setting the initial interval value

- setting range: -99999...999999

TO M Setting the final interval value

- setting range: -99999...999999

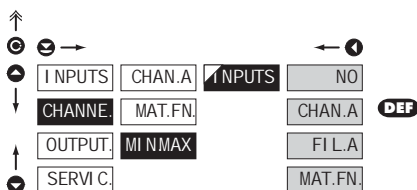
6.2.3 **Selection of evaluation of min/max value**

I NPUTS Selection of evaluation of min/max value

- selection of value from which the min/max value will be calculated

- NO** Evaluation of min/max value is off
- CHAN.A** From "Channel A"
- FIL A** From "Channel A" after digital filters processing
- MAT.FN.** From "Mathematic functions"

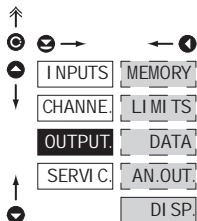
6.3 Setting „PROFI“ - OUTPUTS



In this menu it is possible to set parameters of the instrument output signals

MEMORY	Setting data logging into memory
LIMITS	Setting type and parameters of limits
DATA	Setting type and parameters of data output
AN.OUT.	Setting type and parameters of analog output
DISP.	Setting display projection and brightness

6.3.1a Selection of mode of data logging into instrument memory

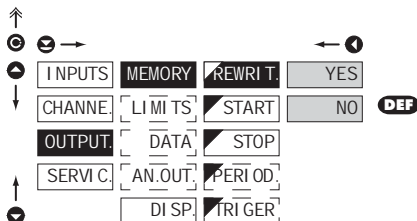

REWRIT. Selection of the mode of data logging

- selection of the mode in the event of full instrument memory

NO	Rewriting values prohibited
YES	Rewriting values permitted, the oldest get rewritten by the latest

6.3.1b Setting data logging into instrument memory - RTC

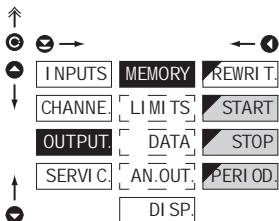

START Start of data logging into instrument memory

- time format HH.MM.SS

STOP Stop data logging into instrument memory

- time format HH.MM.SS

PERI OD. Period of data logging into instrument memory

- determines the period in which values will be logged in an interval delimited by the time set under items **START** and **STOP**

- time format HH.MM.SS

- records are made on a daily basis in selected interval and period

- item not displayed if "SAVE" is selected in menu (**INPUT > EXT. IN.**)

6.3.1c Setting data logging into instrument memory - FAST

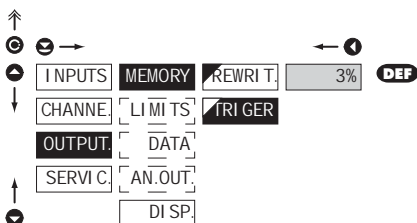

TRI GER Setting logging data into inst. memory

- logging data into inst. memory is governed by the following selection, which determines how many percent of the memory is reserved for data logging prior to initiation of trigger impulse

- initialization is on ext. input or button

- setting in range 1...100 %

- when setting 100 %, datalogging works in the mode **ROLL > data keep** getting rewritten in cycles

1. Memory initialization

- clear memory (ext.input, button)

- LED "M" flashes, after reading **TRIGGER (%)** memory is permanently shining. In **ROLL** flashes constantly.

2. Triggering

- external input, button

- after the memory LED is full "M" turns off

- in the **ROLL** mode the trigger ends datalogging and LED turns off

3. Termination

- ext. input, button or reading data via **RS**

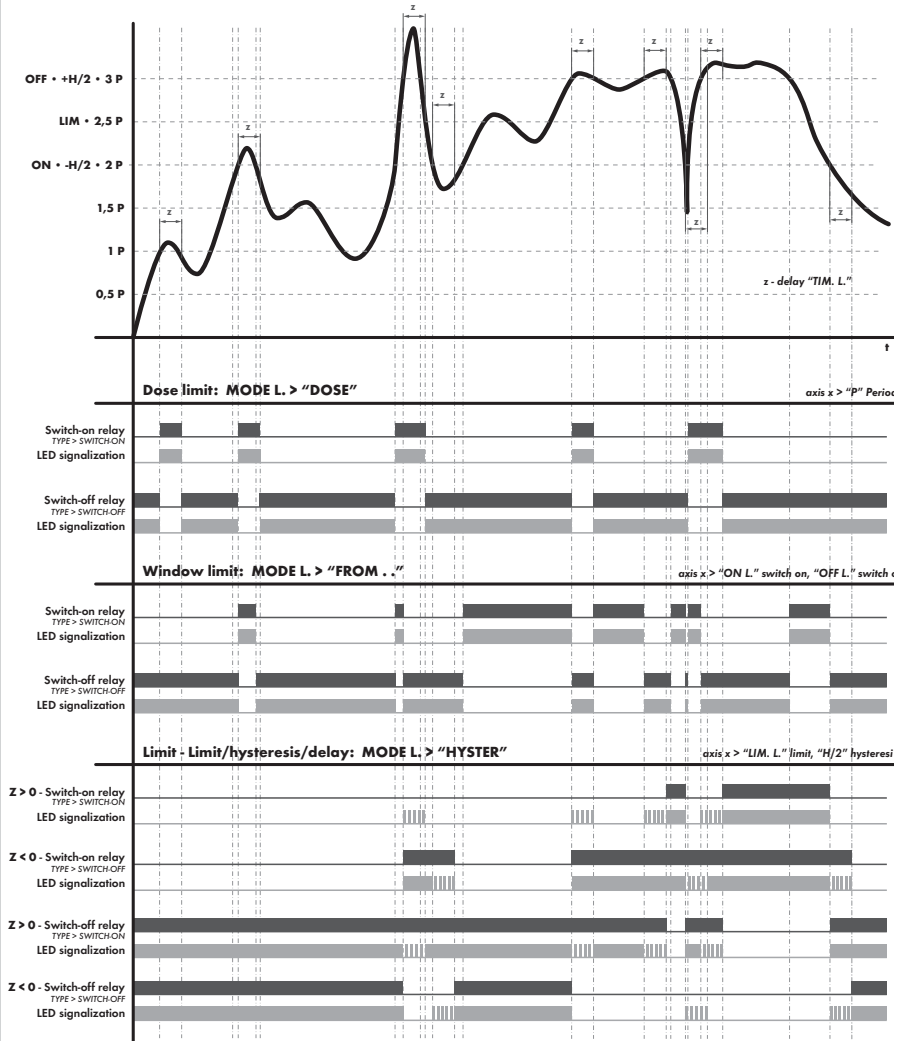

6.3.2a Selection of input for limits evaluation

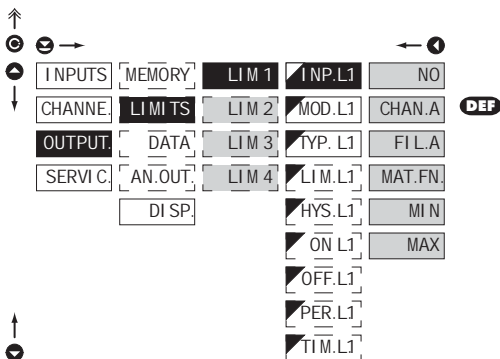

Setting is identical for LIM 2, LIM 3 and LIM 4

INP.L1 Selection evaluation of limits

- selection of value from which the limit will be evaluated

- NO** Limit evaluation is off
- CHAN.A** Limit evaluation from "Channel A"
- FI.LA** Limit evaluation from "Channel A" after digital filters processing
- MAT.FN.** Limit evaluation from "Mathematic functions"
- MIN** Limit evaluation from "Min.value"
- MAX** Limit evaluation from "Max.value"

6.3.2b Selection of type of limit

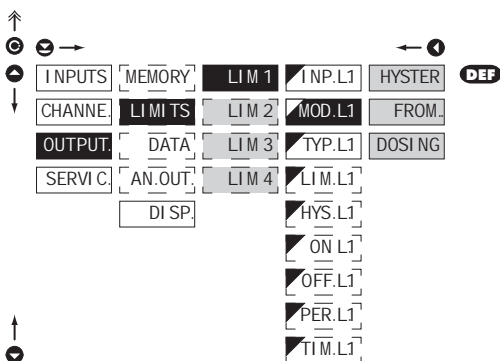

Setting is identical for LIM 2, LIM 3 and LIM 4

MOD.L1 Selection the type of limit

HYSTER Limit is in mode "Limit, hysteresis, delay"

- for this mode the parameters of "LIM. L." are set, at which the limit will shall react, "HYS. L." the hysteresis range around the limit (LIM ±1/2 HYS) and time "TIM. L." determining the delay of relay switch-on

FROM. Frame limit

- for this mode the parameters are set for interval "ON. L." the relay switch-on and "OFF. L." the relay switch-off

DOSING Dose limit (periodic)

- for this mode the parameters are set for "PER. L." determining the limit value as well as its multiples at which the output is active and "TIM. L." indicating the time during which is the output active

6.3.2c Selection of type of output

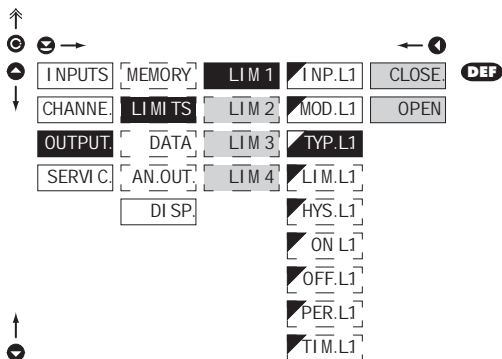
TYP.L1 Selection of type of output

CLOSE. Output switches on when condition is met

OPEN Output switches off when condition is met



Setting is identical for LIM 2, LIM 3 and LIM 4

6.3.2d Setting values for limits evaluation

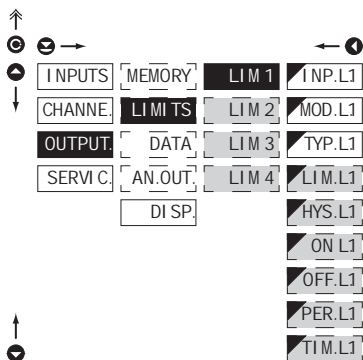
LIM.L1 Setting limit for switch-on

- for type "HYSTER"

HYS.L1 Setting hysteresis

- for type "HYSTER"
- indicates the range around the limit (in both directions, LIM. $\pm 1/2$ HYS.)

ON.L1 Setting the outset of the interval of limit switch-on
- for type "FROM"

OFF.L1 Setting the end of the interval of limit switch-on
- for type "FROM"

PER.L1 Setting the period of limit switch-on
- for type "DOSE"

TIM.L1 Setting the time switch-on of the limit
- for type "HYSTER" and "DOSE"

- setting within the range: $\pm 0...99,9$ s
- positive time > relay switches on after crossing the limit (LIM. L1) and the set time (TIM. L1)
- negative time > relay switches off after crossing the limit (LIM. L1) and the set negative time (TIM. L1)



Setting is identical for LIM 2, LIM 3 and LIM 4

6.3.3a Selection of data output baud rate

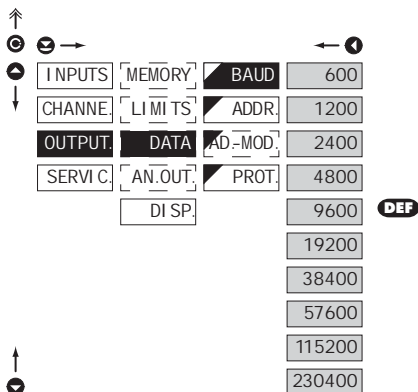

BAUD	Selection of data output baud rate
600	Rate - 600 Baud
1200	Rate - 1 200 Baud
2400	Rate - 2 400 Baud
4800	Rate - 4 800 Baud
9600	Rate - 9 600 Baud
19200	Rate - 19 200 Baud
38400	Rate - 38 400 Baud
57600	Rate - 57 600 Baud
115200	Rate - 115 200 Baud
230400	Rate - 230 400 Baud

6.3.3b Setting instrument address

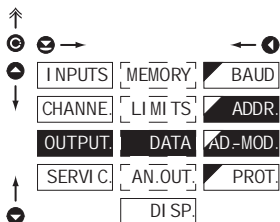

ADDR.	Setting instrument address
-	setting in range 0...31
-	DEF = 00
AD-MOD.	Setting instrument address - MODBUS
-	setting in range 1...247
-	DEF = 1

6.3.3c Selection of data output protocol

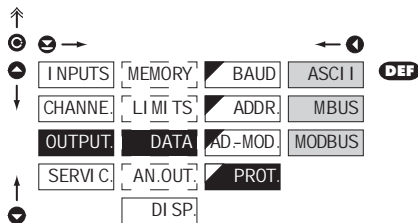

PROT. Selection of the type of analog output

ASCII Data protocol
ASCII

M.BUS Data protocol
DIN MessBus

MODBUS Data protocol
MODBUS-RTU

- option is available only for RS 485

6.3.4a Selection of input for analog output

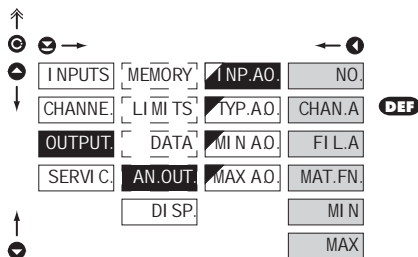

INP.AO. Selection evaluation analog output

- selection of value from which the analog output will be evaluated

NO AO evaluation is off

CHAN.A AO evaluation
from "Channel A"

FIL.A AO evaluation
from "Channel A" after
digital filters processing

MAT.FN. AO evaluation
from "Math.functions"

MIN AO evaluation
from "Min.value"

MAX AO evaluation
from "Max.value"

6.3.4b Selection of the type of analog output

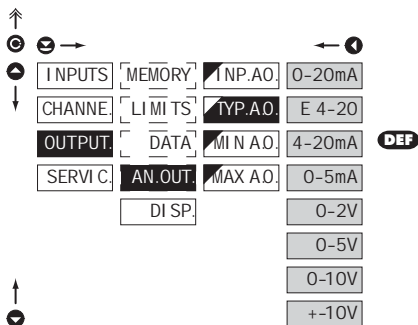

TYP.A.O. Selection of the type of analog output

0-20mA Type - 0...20 mA

E 4-20 Type - 4...20 mA

- with indication of error statement (< 3,0 mA)

4-20mA Type - 4...20 mA

0-5mA Type - 0...5 mA

0-2V Type - 0...2 V

0-5V Type - 0...5 V

0-10V Type - 0...10 V

+/-10V Type - ±10 V

6.3.4c Setting the analog output range

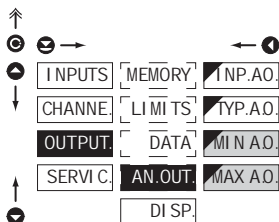

AN.OUT. Setting the analog output range

- analog output is isolated and its value corresponds with displayed data. It is fully programmable, i.e. it allows to assign the AO limit points to two arbitrary points of the entire measuring range

MIN.A.O. Assigning the display value to the beginning of the AO range

- range of the setting is -99999...99999

- **DEF** = 0

MAX.A.O. Assigning the display value to the end of the AO range

- range of the setting is -99999...99999

- **DEF** = 100

6.3.5a Selection of input for display projection

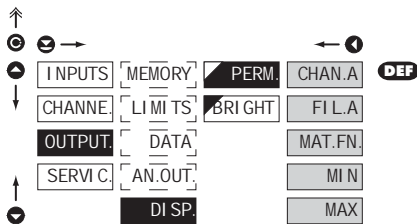

PERM. Selection display projection

- selection of value which will be shown on the instrument display

- CHAN.A Projection of values from "Channel A"
- FIL.A Projection of values from "Channel A" after digital filters processing
- MAT.FN. Projection of values from "Math.functions"
- MIN. Projection of values from "Min.value"
- MAX. Projection of values from "Max.value"

6.3.5b Selection of display brightness

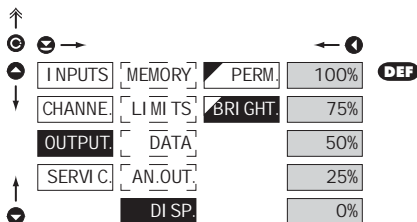

BRIGHT Selection of display brightness

- by selecting display brightness we may appropriately react to light conditions in place of instrument location

- 0% Display is off
- after keystroke display turns on for 10 s
- 25% Display brightness - 25%
- 50% Display brightness - 50%
- 75% Display brightness - 75%
- 100% Display brightness - 100%

6.4 Setting "PROFI" - SERVIS

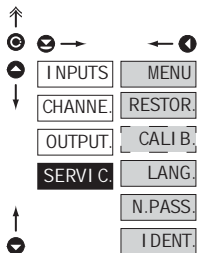

The instrument service functions are set in this menu

MENU	Selection of menu type LIGHT/PROFI
RESTOR.	Restore instrument manufacture setting and calibration
CALI B.	Input range calibration for „DU“ version
LANG.	Language version of instrument menu
N.PASS.	Setting new access password
I DENT.	Instrument identification

6.4.1 Selection of type of programming menu

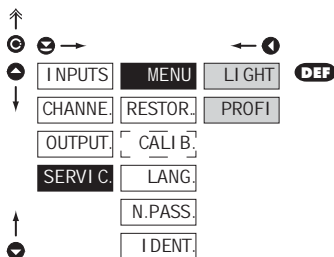

MENU Selection of menu type - LIGHT/PROFI

- enables setting the menu complexity according to user needs and skills

LIGHT Active LIGHT menu

- simple programming menu, contains only items necessary for configuration and instrument setting
- linear menu > items one after another

PROFI Active PROFI menu

- complete programming menu for expert users
- tree menu



Change of setting is valid upon next access into menu

6.4.2 Restoration of manufacture setting

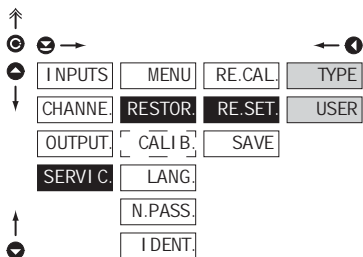
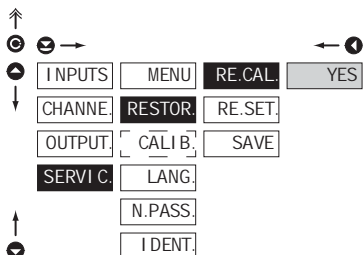

RESTOR. Restoration of manufacture setting

- in the event of error setting or calibration, manufacture setting may be restored.

RE.CAL. Restoration of manufacture calibration of the instrument

- prior executing the changes you will be asked to confirm your selection „YES“

RE.SET. Restoration of instrument manufacture setting

TYPE Restoration of instrument manufacture setting

- generating the manufacture setting for currently selected type of instrument (items marked DEF)

USER Restoration of instrument user setting

- generating the instrument user setting, i.e. setting stored under SERVIC./RESTOR./SAVE

SAVE Save instrument user setting

- storing the user setting allows the operator to restore it in future if needed



After restoration the instrument switches off for couple seconds

Jobs performed	Restore	
	Calibration	Setting
cancels USER menu rights	✓	✓
deletes table of items order in USER - LIGHT menu	✓	✓
adds items from manufacture to LIGHT menu	✓	✓
deletes data stored in FLASH	✓	✓
cancels or linearization tables	✓	✓
clears tare	✓	✓
clears conduct resistances	✓	✓
restore manufacture calibration	✓	x
restore manufacture setting	x	✓

6.4.3 Calibration - Input range

DU

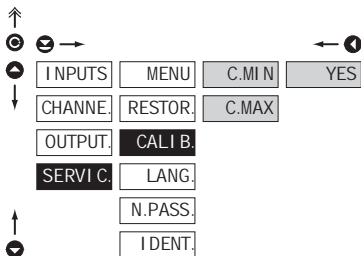

CALI B. Input range calibration

- when "C. MIN" is displayed, move the potentiometer traveller to the required minimum position and confirm by „Enter“, calibration is confirmed by "YES"
- when "C. MAX" is displayed, move the potentiometer traveller to required maximum position and confirm by „Enter“, calibration is confirmed by „YES"

6.4.4 Selection of instrument menu language version

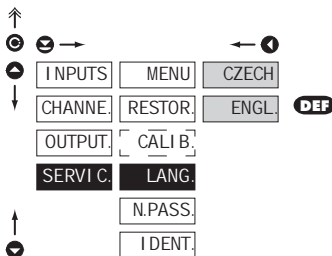

LANG. Selection of instrument menu language version

- CZECH** Instrument menu is in Czech
- ENGL.** Instrument menu is in English

6.4.5 Setting new access password

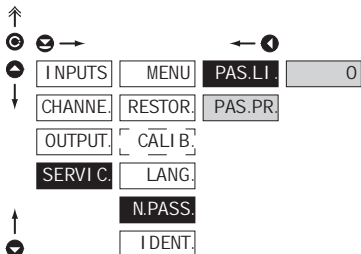

N.PASS. Setting new password for access to LIGHT and PROFÍ menu

- this option allows to change the numeric code, which blocks the access into LIGHT and PROFÍ Menu.
- numeric code range: 0...9999
- universal passwords in the event of loss:
LIGHT Menu > „8177“
PROFÍ Menu > „7915“

6.4.6 Instrument identification

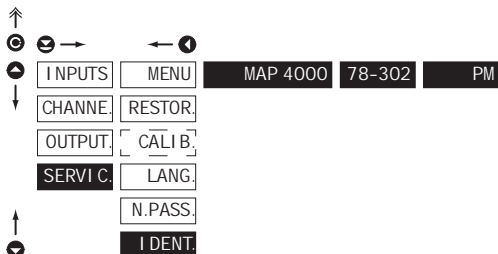

I DENT. Projection of instrument SW version

- display shows type identification of the instrument, SW number, SW version and current input setting (Mode)
- if the SW version reads a letter on first position, it is a customer SW

I DENT.	pos	Description
	1.	type of instrument
	2.	SW: number - version
	3.	the input type

7.0 Setting items into "USER" menu

- **USER** menu is designed for users who need to change only several items of the setting without the option to change the primary instrument setting (e.g. repeated change of limit setting)
- there are no items from manufacture permitted in **USER** menu
- on items indicated by inverse triangle  L 1
- setting may be performed in **LIGHT** or **PROFI** menu, with the **USER** menu then overtaking the given menu structure



- For user operation
- Menu items are set by the user (Profi/Light) as per request
- Access is not password protected

Setting

flashing legend - current setting is displayed



NO

item will not be displayed in USER menu

YES

item will be displayed in USER menu with editing option

SHOW

item will be solely displayed in USER menu

Setting sequence of items in "USER" menu

In compiling USER menu from active LIGHT menu the items (max. 10) may be assigned a sequence, in which they will be projected in the menu



Example:

Into USER menu were selected these items

(keys +) > CL. TAR., LIM 1, LIM 2, LIM 3, for which we have preset this sequence (keys +):

CL. TAR.	5
LIM 1	0 (sequence not determined)
LIM 2	2
LIM 3	1

Upon entering USER menu

(key) items will be projected in the following sequence: LIM 3 > LIM 2 > CL.TAR. > LIM 1

Instrument with input for temperature measurement with thermocouple allows to set two types of measurement of cold junction.

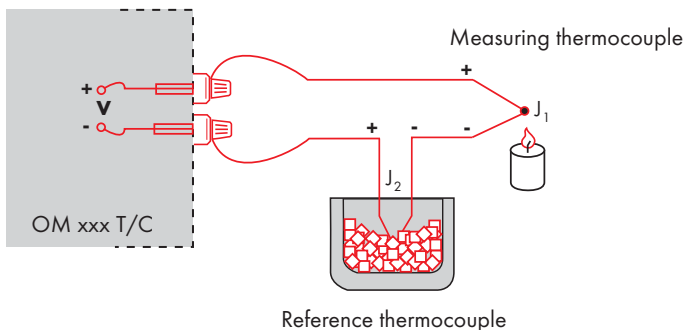

WITH REFERENCE THERMOCOUPLE

- a reference thermocouple may be located in the same place as the measuring instrument or in place with stable temperature/compensation box
- when measuring with reference thermocouple set **CONNECT.** in the instrument menu to **I NT2TC** or **EXT2TC**
- when using a thermostat (a compensation box or environment with constant temperature) set in the instrument menu **CJCTEM.** its temperature (applies for setting **CONNECT.** to **EXT2TC**)
- if the reference thermocouple is located in the same environment as the measuring instrument then set in the instrument menu **CONNECT.** to **I NT2TC.** Based on this selection the measurement of the ambient temperature is performed by a sensor located in the instrument terminal board.

WITHOUT REFERENCE THERMOCOUPLE

- inaccuracy originating from the creation of dissimilar thermocouples on the transition point terminal/conductor of the thermocouple is not compensated for in the instrument
- when measuring without reference thermocouple set **CONNECT.** in the instrument menu to **I NT1TC** or **EXT1TC**
- when measuring temperature without reference thermocouple the error in measured data may be as much as 10 °C (applies for setting **CONNECT.** to **EXT1TC**)

The instruments communicate via serial line RS232 or RS485. For communication they use the ASCII protocol. Communication runs in the following format:

ASCII: 8 bit, no parity, one stop bit
 DIN MessBus: 7 bit, even parity, one stop bit

The transfer rate is adjustable in the instrument menu. The instrument address is set in the instrument menu in the range of 0 ÷ 31. The manufacture setting always presets the ASCII protocol, rate of 9600 Baud, address 00. The type of line used - RS232 / RS485 - is determined by an output board automatically identified by the instrument.

DETAILED DESCRIPTION OF COMMUNICATION VIA SERIAL LINE

Event	Type	Protocol	Transmitted data																		
Data solicitation (PC)	232	ASCII	#	A	A	<CR>															
		MessBus	No - data is transmitted permanently																		
	485	ASCII	#	A	A	<CR>															
		MessBus	<SADR>	<ENQ>																	
Data transmission (instrument)	232	ASCII	>	D	(D)	(D)	(D)	(D)	(D)	(D)	(D)	(D)	(D)	(D)	(D)	(D)	(D)	(D)	<CR>		
		MessBus	<SADR>	D	(D)	(D)	(D)	(D)	(D)	(D)	(D)	(D)	(D)	(D)	(D)	(D)	(D)	(D)	(D)	<ETX>	<BCC>
	485	ASCII	>	D	(D)	(D)	(D)	(D)	(D)	(D)	(D)	(D)	(D)	(D)	(D)	(D)	(D)	(D)	<CR>		
		MessBus	<SADR>	D	(D)	(D)	(D)	(D)	(D)	(D)	(D)	(D)	(D)	(D)	(D)	(D)	(D)	(D)	(D)	<ETX>	<BCC>
Confirmation of data acceptance (PC) - OK	485	MessBus	<DLE>	1																	
Confirmation of data acceptance (PC) - Bad			<NAK>																		
Sending address (PC) prior command			<EADR>	<ENQ>																	
Confirmation of address (instrument)			<SADR>	<ENQ>																	
Command transmission (PC)	232	ASCII	#	A	A	N	P	(D)	(D)	(D)	(D)	(D)	(D)	(D)	(D)	(D)	(D)	(D)	<CR>		
		MessBus	<STX>	\$	N	P	(D)	(D)	(D)	(D)	(D)	(D)	(D)	(D)	(D)	(D)	(D)	(D)	<ETX>	<BCC>	
	485	ASCII	#	A	A	N	P	(D)	(D)	(D)	(D)	(D)	(D)	(D)	(D)	(D)	(D)	(D)	<CR>		
		MessBus	<SADR>	\$	N	P	(D)	(D)	(D)	(D)	(D)	(D)	(D)	(D)	(D)	(D)	(D)	(D)	<ETX>	<BCC>	
Command confirmation (instrument)	232	ASCII	OK	!	A	A	<CR>														
			Bad	?	A	A	<CR>														
		MessBus	No - data is transmitted permanently																		
	485	ASCII	OK	!	A	A	<CR>														
			Bad	?	A	A	<CR>														
		MessBus	OK	<DLE>	1																
			Bad	<NAK>																	
Command confirmation (inst.) - OK	485	MessBus	!	A	A	<CR>															
Command confirmation (instrument) - Bad			?	A	A	<CR>															
Instrument identification			#	A	A	1Y	<CR>														
HW identification			#	A	A	1Z	<CR>														
One-time transmission			#	A	A	7X	<CR>														
Repeated transmission			#	A	A	8X	<CR>														

LEGEND

#	35	23 _H	Command beginning
A	A	0...31	Two characters of instrument address (sent in ASCII - tens and units, e.g. "01", "99" universal
<CR>	13	0D _H	Carriage return
<SP>	32	20 _H	Space
N, P			Number and command - command code
D			Data - usually characters "0"... "9", ".", "-", ";"; (D) - dp. and (-) may prolong data
R	30 _H ...3F _H		Relay and tare status
!	33	21 _H	Positive confirmation of command (ok)
?	63	3F _H	Negative confirmation of command (point)
>	62	3E _H	Beginning of transmitted data
<STX>	2	02 _H	Beginning of text
<ETX>	3	03 _H	End of text
<SADR>	address +60 _H		Prompt to send from address
<EADR>	address +40 _H		Prompt to accept command at address
<ENQ>	5	05 _H	Terminate address
<DLE>1	16 49	10 _H 31 _H	Confirm correct statement
<NAK>	21	15 _H	Confirm error statement
<BCC>			Check sum -XOR

RELAY, TARE

Sign	Relay 1	Relay 2	Tare	Change relay 3/4
P	0	0	0	0
Q	1	0	0	0
R	0	1	0	0
S	1	1	0	0
T	0	0	1	0
U	1	0	1	0
V	0	1	1	0
W	1	1	1	0
p	0	0	0	1
q	1	0	0	1
r	0	1	0	1
s	1	1	0	1
t	0	0	1	1
u	1	0	1	1
v	0	1	1	1
w	1	1	1	1

Relay status is generated by command #AA6X<CR>. The instrument immediately returns the value in the format >HH<CR>, where HH is value in HEX format and range 00_H...FF_H. The lowest bit stands for „Relay 1“, the highest for „Relay 8“

ERROR	CAUSE	ELIMINATION
E.D.Un.	Number is too small (large negative) to be displayed	change DP setting, channel constant setting
E.D.Ov.	Number is too large to be displayed	change DP setting, channel constant setting
E.T.Un.	Number is outside the table range	increase table values, change input setting (channel constant setting)
E.T.Ov.	Number is outside the table range	increase table values, change input setting (channel constant setting)
E.I.Un.	Input quantity is smaller than permitted input quantity range	change input signal value or input (range) setting
E.I.Ov.	Input quantity is larger than permitted input quantity range	change input signal value or input (range) setting
E.HW.	A part of the instrument does not work properly	send the instrument for repair
E.EE	Data in EEPROM corrupted	perform restoration of manufacture setting, upon repeated error statement send instrument for repair
E.SET	Data in EEPROM outside the range	perform restoration of manufacture setting, upon repeated error statement send instrument for repair
E.CLR.	Memory was empty (presetting carried out)	upon repeated error statement send instrument for repair, possible failure in calibration

The instrument allows to add two descriptive characters to the classic numeric formats (at the expense of the number of displayed places). The setting is performed by means of a shifted ASCII code. Upon modification the first two places display the entered characters and the last two places the code of the relevant symbol from 0 to 95. Numeric value of given character equals the sum of the numbers on both axes of the table.

Description is cancelled by entering characters with code 00

0		Q	"	£	\$	¥	€	'	0		!	"	#	\$	%	&	'
8	()	*	+	,	-	.	/	8	()	*	+	,	-	.	/
16	0	1	2	3	4	5	6	7	16	0	1	2	3	4	5	6	7
24	8	9	VA	Vr	<	=	>	?	24	8	9	VA	Vr	<	=	>	?
32	Q	R	B	C	D	E	F	G	32	@	A	B	C	D	E	F	G
40	H	I	J	K	L	M	N	O	40	H	I	J	K	L	M	N	O
48	P	Q	R	S	T	U	V	W	48	P	Q	R	S	T	U	V	W
56	X	Y	Z	[\]	^	_	56	X	Y	Z	[\]	^	_
64	`	a	b	c	d	e	f	g	64	`	a	b	c	d	e	f	g
72	h	i	j	k	l	m	n	o	72	h	i	j	k	l	m	n	o
80	p	q	r	s	t	u	v	w	80	p	q	r	s	t	u	v	w
88	X	Y	Z	{		}	~		88	x	y	z	{		}	~	

INPUT

range is adjustable

±60 mV	>100 MOhm
±150 mV	>100 MOhm
±300 mV	>100 MOhm
±1200 mV	>100 MOhm

DC

Input U
Input U
Input U
Input U

range is adjustable

±0,1 A	< 300 mV
±0,25 A	< 300 mV
±0,5 A	< 300 mV
±1 A	< 30 mV
±5 A	< 150 mV
±100 V	20 MOhm
±250 V	20 MOhm
±500 V	20 MOhm

DC - option "A"

Input I
Input I
Input I
Input I
Input I
Input U
Input U
Input U

range is adjustable

0/4...20 mA	< 400 mV
±2 V	1 MOhm
±5 V	1 MOhm
±10 V	1 MOhm
±40 V	1 MOhm

PM

Input I
Input U
Input U
Input U
Input U

range is adjustable

0...100 Ohm
0...1 kOhm
0...10 kOhm
0...100 kOhm
Autorange

OHM

Connection:

2, 3 or 4 wire

Pt xxxx

-200°...850°C

RTD

Pt xxxx/3910 ppm

-200°...1 100°C

Ni xxxx

-50°...250°C

Cu/4260 ppm

-50°...200°C

Cu/4280 ppm

-200°...200°C

Type Pt:

EU > 100/500/1 000 Ohm, with 3 850 ppm/°C

US > 100 Ohm, with 3 920 ppm/°C

RU > 50/100 Ohm, with 3 910 ppm/°C

Type Ni:

Ni 1 000/ Ni 10 000 with 5 000/6 180 ppm/°C

Type Cu:

Cu 50/Cu 100 with 4 260/4 280 ppm/°C

Connection:

2, 3 or 4 wire

range is adjustable in configuration menu

Type:

J (Fe-CuNi)	-200°...900°C
K (NiCr-Ni)	-200°...1 300°C
T (Cu-CuNi)	-200°...400°C
E (NiCr-CuNi)	-200°...690°C
B (PtRh30-PtRh6)	300°...1 820°C
S (PtRh10-Pt)	-50°...1 760°C
R (Pt13Rh-Pt)	-50°...1 740°C
N (Omegalloy)	-200°...1 300°C
L (Fe-CuNi)	-200°...900°C

T/C

Voltage of lin. pot.

2,5 VDC/6 mA

min. potentiometer resistance is 500 Ohm

DU

PROJECTION

Display:

999999, intensive red or green
14-ti segment LED, digit height 14 mm
±9999 (-99999...999999)

Projection:

adjustable - in menu

Brightness:

adjustable - in menu

INSTRUMENT ACCURACY

TC:

100 ppm/°C

Accuracy:

±0,1 % of range + 1 digit

±0,15 % of range + 1 digit

RTD, T/C

Above accuracies apply for projection 9999

Resolution:

0,01°/0,1°/1°

RTD

Rate:

0,1...40 measurements/s**

Overload capacity:

10x (t < 100 ms) not for 400 V and 5 A,
2x (long-term)

Linearisation:

by linear interpolation in 50 points

Digital filters:

Averaging, Floating average, Exponential filter, Rounding

Comp. of conduct:

max. 40 Ohm/100 Ohm

RTD

Comp. of cold junct.:

adjustable

T/C

Functions:

Tare - display resetting
Hold - stop measuring (at contact)
Lock - control key locking
MM - min/max value
Mathematic functions

Watch-dog:

reset after 400 ms

Calibration:

at 25°C and 40 % of r.h.

COMPARATOR

Type:

digital, adjustable in menu

Mode:

Hysteresis, From, Dosing

Limita:

-99999...999999

Hysteresis:

0...999999

Delay:

0...99,9 s

Outputs:

2x relays with switch-on contact (Form A)
(230 VAC/30 VDC, 3 A)*
2x relays with switch-off contact (Form C)
(230 VAC/50 VDC, 3 A)*
2x SSR (250 VAC/1 A)*

2x/4x open collector (30 VDC/100 mA)

2x bistabil relays (250 VAC/250 VDC, 3 A/0,3 A)*

Relay:

1/8 HP 277 VAC, 1/10 HP 125 V, Pilot Duty D300

* values apply for resistance load

DATA OUTPUTS

Protocols:	ASCII, DIN MessBus, MODBUS, PROBUS
Data format:	8 bit + no parity + 1 stop bit (ASCII) 7 bit + even parity + 1 stop bit (MessBus)
Rate:	600...230 400 Baud 9 600 Baud...12 Mbaud (PROFIBUS)
RS 232:	isolated, two-way communication
RS 485:	isolated, two-way communication, addressing (max. 31 instruments)
PROFIBUS	Data protocol SIEMENS

ANALOGUE OUTPUTS

Type:	isolated, programmable with resolution of max.10 000 points, analog output corresponds with displayed data, type and range are adjustable
Non-linearity:	0,2 % of range
TC:	100 ppm/°C
Rate:	response to change of value < 150 ms
Voltage:	0...2 V/5 V/10 V/±10 V
Current:	0...5/20 mA/4...20 mA - compensation of conduct to 500 Ohm/12 V or 1 000 Ohm/24 V

MEASURED DATA RECORD

Type RTC:	time-controlled logging of measured data into instrument memory, allows to log up to 250 000 values
Type FAST:	fast data logging into instrument memory, allows to log up to 8 000 values at a rate of 40 records/s
Transmission:	via data output RS 232/485

EXCITATION

Adjustable:	5...24 VDC/max. 1,2 W, isolated
-------------	---------------------------------

POWER SUPPLY

Options:	10...30 V AC/DC, 10 VA, isolated, - fuse inside (T 4000 mA) 80...250 V AC/DC, 10 VA, isolated - fuse inside (T 6300 mA)
----------	--

MECHANIC PROPERTIES

Material:	Noryl GFN2 SE1, incombustible UL 94 V-1
Dimensions:	96 x 48 x 120 mm
Panel cut-out:	90,5 x 45 mm

OPERATING CONDITIONS

Connection:	connector terminal board, conductor cross-section <1,5 mm ² / <2,5 mm ²
Stabilisation period:	within 15 minutes after switch-on
Working temp.:	0°...60°C
Storage temp.:	-10°...85°C
Cover:	IP65 (front panel only)
Construction:	safety class I
Dielectric strength:	4 kVAC after 1 min between supply and input 4 kVAC after 1 min between supply and data/analog output 4 kVAC after 1 min between supply and relay output 2,5 kVAC after 1 min between supply and data/analog output
Overvoltage category:	EN 61010-1, A2
Insulation resistance:	for pollution degree II, measurement category III instrum.power supply > 670 V (PI), 300 V (DI) Input/output > 300 V (PI), 150 (DI)
EMC:	EN 61000-3-2+A12; EN 61000-4-2, 3, 4, 5, 8, 11; EN 550222, A1, A2
Seismic resistance:	IEC 980: 1993, par. 6

**Table of rate of measurement in relation to number of inputs

Channels/Rate	40	20	10	5	2	1	0,5	0,2	0,1
No. of channels: 1 (Type: DC, PM, DU)	40,00	20,00	10,00	5,00	2,00	1,00	0,50	0,20	0,10
No. of channels: 2	5,00	2,50	1,25	1,00	0,62	0,38	0,22	0,09	0,05
No. of channels: 3	3,33	1,66	0,83	0,66	0,42	0,26	0,14	0,06	0,03
No. of channels: 4	2,50	1,25	0,62	0,50	0,31	0,19	0,11	0,05	0,02
No. of channels: 1 (Type: OHM, RTD, T/C)	5,00	2,50	1,25	1,00	0,62	0,38	0,22	0,09	0,05
No. of channels: 2	3,33	1,066	0,83	0,66	0,42	0,26	0,14	0,06	0,03
No. of channels: 3	2,50	1,25	0,62	0,50	0,31	0,19	0,11	0,05	0,02
No. of channels: 4	2,00	1,00	0,50	0,40	0,25	0,15	0,08	0,04	0,02

PI - Primary insulation, DI - Double insulation

Front view



Panel cut

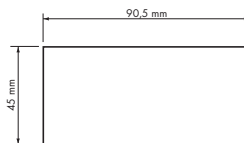

Side view

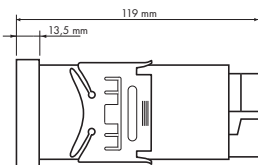

Panel thickness: 0,5...20 mm

Instrument installation

1. insert the instrument into the panel cut-out
2. fit both travellers on the box
3. press the travellers close to the panel

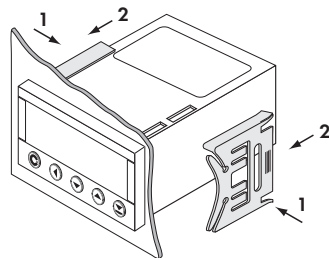
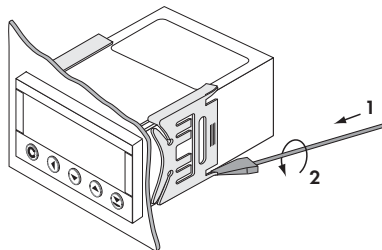

Instrument disassembly

1. slide a screw driver under the traveller wing
2. turn the screw driver and remove the traveller
3. take the instrument out of the panel

Product **MAP 4000**
 Type
 Manufacturing No.
 Date of sale

GUARANTEE

A guarantee period of 60 months from the date of sale to the user applies to this instrument.
 Defects occurring during this period due to manufacture error or due to material faults shall be eliminated free of charge.

For quality, function and construction of the instrument the guarantee shall apply provided that the instrument was connected and used in compliance with the instructions for use.

The guarantee shall not apply to defects caused by:

- mechanic damage
- transportation
- intervention of unqualified person incl. the user
- unavoidable event
- other unprofessional interventions

The manufacturer performs guarantee and post.guarantee repairs unless provided for otherwise.

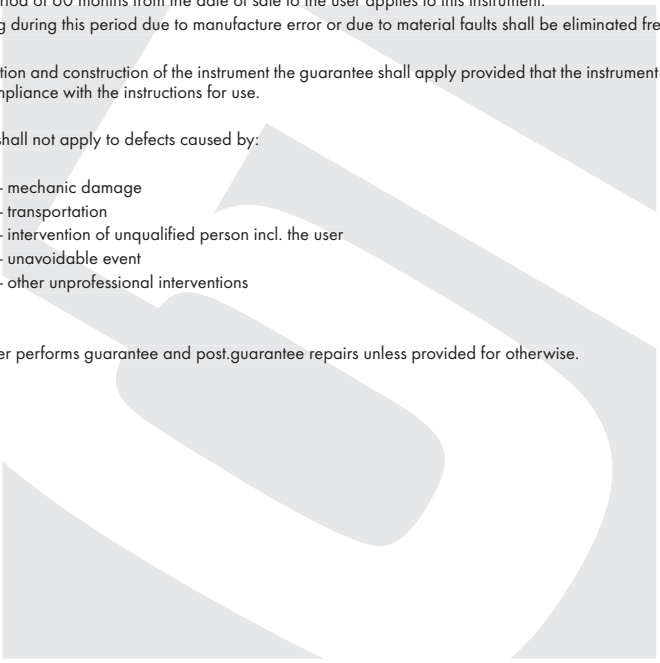

Y E A R S

Stamp, signature

